

Overkill Solar BMS Instruction Manual

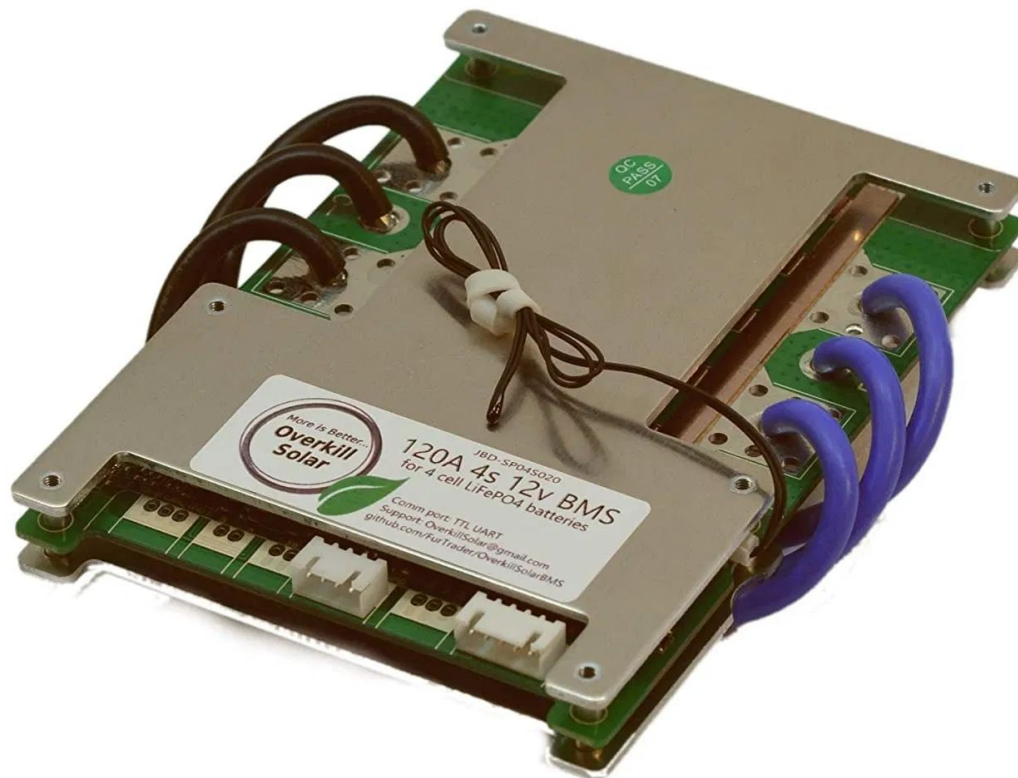

Version: 0.1.0

Date: August 31, 2020

Table of Contents

Table of Contents	2
1. Introduction	5
1.1 What is a BMS	5
2. How to Build a Battery Pack	5
2.1 Safety Precautions	5
2.2 Planning	5
2.2.1 Gather Components	5
2.2.2 Gather Consumables	6
2.2.2 Gather Tools	7
2.3 Top Balancing	7
2.4 Assembly	9
2.4.1 Arranging the Cells	9
2.4.2 Connect the Balance Wires	10
2.4.3 Prepare BMS	11
2.4.3 Add BMS	11
2.4.5 Temperature Sensor	11
2.4.6 External Switch	12
2.4.7 Connectivity	13
2.4.7.1 Bluetooth Module	13
2.4.7.1 USB Interface	13
2.4.7.3 Arduino LCD Display	15
3. BMS Parameters	15
3.1 Protection Parameters	15
3.1.1 Cell over voltage	15
3.1.2 Cell under voltage	15
3.1.3 Battery over voltage	16
3.1.4 Battery under voltage	16
3.1.5 Charge over current	17
3.1.6 Discharge over current	17
3.1.7 Charge over temperature	18
3.1.8 Charge under temperature	18
3.1.9 Discharge over temperature	18
3.1.10 Discharge under temperature	18
3.2 Capacity Parameters	18
3.2.1 Designed Capacity	18
3.2.2 Cycle Capacity	19
3.2.3 Full Charge Voltage	19
3.2.4 End of Discharge Voltage	19
3.2.5 Discharge Rate	19

3.2.6 80%, 60%, 40%, 20% Capacity Voltage Levels	19
3.3 Balance Parameters	20
3.3.1 Start Voltage	20
3.3.2 Delta to balance	20
3.3.3 Balancer Enabled	20
3.3.4 Balance only when Charging	20
3.4 Other Parameters / Features	20
3.4.1 Switch	20
3.4.2 Load Detect	20
3.4.3 LED Enabled	20
3.4.4 LED Capacity	21
3.4.5 BMS Name	21
3.4.6 Barcode	21
3.4.7 NTC Settings	21
4. Periodic Maintenance	22
4.1 Periodic Cable Check	22
4.2. Periodic Voltage Check	22
5. Troubleshooting & FAQ	23
6. Technical Support, Return, and Refund Policy	27
Appendix	28
Appendix A: Recommended Parameters	28
A.1 General Settings	28
A.2: 12V Pack, 4 Cell, Using One 12V BMS and 100Ah LiFEPO4 cells	29
Mechanical Drawing	29
Bill of Materials	29
Wiring Diagram	31
BMS Configuration Parameters	31
A.3: 12V Pack, 8 Cell, Using One 12V BMS	32
A.4: 24V Pack, 8 Cell, Using One 24V BMS	32
A.5: 24V Pack, 8 Cell, Using Two 12V BMSs	33
A.6: 24V Pack, 16 Cell, Using One 24V BMS	33
A.7: 48V Pack, 16 Cell, Using Two 24V BMSs	33
Appendix B: Calibration	34
B.1 Voltage Calibration	34
B.2 Current Calibration	35
B.2.1 Idle Current Calibration	35
B.2.2 Charge Current Calibration	36
B.2.3 Discharge Current Calibration	38
Appendix C: About Cell Balancing	40
Appendix D: BMS Specifications	46
D.1. Pinouts	47
D.1.1 BMS Balance Connector (12V)	47

12V BMS connector:	47
24V BMS connector:	47
D.1.2 BMS Serial Interface Connector	48
D.1.3 BMS Switch Connector	49
D.1.4 BMS Temp Sensor Connector	50
Appendix E: BMS Application Usage	50
E.1. XiaoxiangBMS (iPhone)	50
E.2. Xiaoxiang (Android)	51
E.3. JBTools (PC)	54
Appendix F: Wire and Lug Sizing	57
F.1 Wire Sizing Chart	57
F.2 Battery Bus Bar Sizing Chart	57
Appendix G: Glossary	58
Appendix H: Further Reading	59
H.1 Mobile Solar Power Made Easy! By Will Prowse	59

1. Introduction

1.1 What is a BMS

A battery management system, or BMS, is an electronic device that protects and manages rechargeable battery cells.

2. How to Build a Battery Pack

2.1 Safety Precautions

- Keep metal tools away from exposed terminals
- Wear safety glasses
- Battery cells and electronics can overheat and cause fires or release toxic smoke, if they are misconfigured or used incorrectly. Always keep a [Class C fire extinguisher](#) near the battery system, and ensure that those around it are properly trained to use it.
- Ensure that the all electrical connections are screwed down tight and are not loose
- Battery systems are not a toy. Never let unsupervised children or pets near the battery system.
- Do not connect anything but the BMS's B- cable to the cell negative BC0 terminal (the one exception being the BC0 balance wire). The load negative must be wired to the BMS's C- lead.
- Do not purposely short-circuit the battery pack
- Do not accidentally short-circuit the battery pack
- Do not submerge the battery pack
- Do not purposely connect the battery pack to a load that dissipates more than the BMS is rated to handle.

2.2 Planning

2.2.1 Gather Components

- **Battery cells** (we recommend the Overkill Solar [100Ah LiFePO4 cells](#), which are the perfect size for our BMS modules). We also give very detailed diagrams, mechanical drawings, bill-of-materials, and BMS configuration parameters to ensure a smoother DIY experience.
- **Bus bars** (used to link the battery cells together. While it's possible to use stranded insulated wire and ring terminals, this is considered bad practice, and is arguably more expensive). The easiest approach is to purchase properly-sized bus bars with your battery cells (Overkill Solar's 100 Ah LiFePO4 cells include bus bars). If you purchased other batteries that did not come with bus bars, they may be made from copper bar or pipe; see **Appendix F.2**.
- The **Overkill Solar BMS**, which ships with the following items:
 - Balancing lead
 - Temperature sensors
 - 2-pin cable for external switch
 - Quick-start guide
 - Bluetooth module and cable (optional)

- USB module and cable (optional)
- The BMS may be ordered with optional cable upgrade (C- and B- cables can be upgraded to 8 AWG, 12" or 24" cables. see section 2.2.3 for why this may be useful). Crimped copper lugs may also be specified at order-time.
- A pair of **power distribution blocks**, with two or more 3/8" lugs, rated for at least 150 amps (most with 3/8" lugs will be rated for over 200 amps). We recommend a matched pair with one black for negative, and one red for positive. These will be the interface between the battery pack, and the rest of your system.
- An **enclosure** for your battery pack. Popular choices are:
 - Overkill Solar sells a stainless steel frame for the 100Ah LiFePO4 batteries. This is arguably the strongest and most durable way to build a battery pack, and would be suitable for mobile installations, for example an RV.
 - 1/2" plywood is a very popular choice. This can be assembled in a few hours with very basic tools. A pocket-hole jig (e.g.: Kreg K4) is the quickest and easiest way to attach 1/2" plywood at 90 degree angles without splitting the material.
 - Plastic snap-top battery boxes can be purchased for under \$10.00, and are intended to be used in a mobile setup (e.g. RV or boat). They have locking lids, adjustable dividers, two handles, a recess for a mounting strap, and pass-throughs for large battery cables.
 - Any large plastic box will suffice for a permanent, non-mobile installation. Storage boxes from companies such as Rubbermaid and Sterilite are available in a multitude of shapes and sizes.
 - Many DIYers will also choose to forgo the enclosure altogether. Typically, the electronic components are mounted to a piece of vertical 1/2" plywood, and the batteries are usually placed near the floor, but ideally elevated up a few inches. Sitting on a closet shelf is perfectly fine. These cells do not offgas in normal operation, so they may be placed inside a living space. Admittedly this setup isn't for everyone, but it might be the right choice for some people.

2.2.2 Gather Consumables

- **16-22 AWG Insulated ring terminals** (needed for the balance leads). We include 3/8" ring terminals with the Overkill Solar 100Ah LiFePO4 batteries, which have 10mm lugs. If purchasing other batteries, you will need to provide your own.
- **8-10 AWG ring terminals** (needed to connect the BMS's pig-tail leads to the battery). Crimped ring terminals and longer pigtail leads are optional items for the BMS at the time of purchase. See the Bill-of-materials in [Appendix B](#) for exact sizes.
- **4 AWG, 2 AWG, 1 AWG, 1/0 AWG, or 2/0 AWG stranded insulated wire, 3/8" ring terminals, and heat-shrink tubing** (exact size will depend on the charge and discharge currents. See [Appendix B](#) for bill-of-materials for specific configurations. See [Appendix F](#) for wire sizing guidelines).
- **Kapton tape** (needed to secure the temperature sensor(s). We recommend every DIYer to have Kapton tape on hand. Buy it in assorted sizes). If you don't have Kapton tape, or don't want to buy it, you can use whatever tape you have laying around.
- **2" gaffer tape** (optional; if you plan to tape your batteries together instead of fastening them inside of a box or within a frame) We recommend gaffer tape because it does not leave a residue in most cases. Duct tape works too, but gaffer tape is superior. And if you don't have either of those, then any tape will work in a pinch.
- **Double-sided foam tape** (optional; place between battery cells to prevent them from sliding around, and also as a convenient way to attach the BMS to the battery pack. We recommend 3M™ VHB tape, and this is what gets included with the 100Ah LiFePO4 frame kits).
- **Light-duty 6" zip ties** (for wire bundle management)

- **Heavy-duty >12” zip ties** (Optional; for mounting the BMS to the battery pack)

2.2.2 Gather Tools

- **Ratcheting insulated terminal crimper** (needed for crimping insulated ring terminals to the balance leads). Most ratcheting crimpers will be rated for 10-22 AWG, and have three separate crimping zones: red, blue, and yellow.
- **Hammer lug crimper** or **hydraulic crimper** (needed for crimping the heavy-gauge ring terminals)
- **Cable-stripping knife** (needed for stripping large-gauge wire) A razor blade or a knife are acceptable substitutes, but aren't as safe to use.
- **Wire strippers**, capable of stripping 26 AWG, Klein Tools 11057 or similar (needed to strip the balance leads)
- **Wire shears**, Klein Tools 63050 or similar (needed to cut the large-gauge cables)
- **Socket and wrench set** (needed to tighten the battery lugs). The recommended Overkill Solar 100Ah LiFePO4 cells come with 17mm nylon-insert locking nuts.
- A **phone, tablet with Bluetooth, or a laptop with USB** (Optional; Can be used for programming the BMS. Programming is not needed for common configurations). See [Appendix A](#) for recommended parameters, and [Appendix E](#) for installation and usage.
- A **felt-tip pen** or **label maker** for labelling the cells and balance leads
- A **lab CC-CV power supply** capable of around 10 amps or **LiFePO4 battery charger** capable of charging a single cell (one or the other is needed for top-balancing the cells). Note that if you ordered the cells from Overkill Solar 100Ah LiFePO4 cells, and they were all ordered at the same time, the top-balancing step can be skipped because it was done before they were shipped to you. The top balancing procedure is covered in [Section 2.3](#).
- A **handheld voltmeter** for troubleshooting and BMS calibration. If you plan to calibrate your BMS, the voltmeter needs to be accurate to at least 1 millivolt. If you use a cheap or badly-calibrated voltmeter, you will only make your calibration worse.
- A **clamp-style current meter** (optional; but required for BMS calibration). Most handheld multimeters will only measure DC current up to 10 amps; these are not sufficient. We recommend a clamp meter capable of measuring DC current at greater than 100 amps, at an accuracy better than +/- 2.0%. If purchasing a new clamp meter, always make 100% sure that it will measure DC current. Cheaper models only measure AC current.

2.3 Top Balancing

Before the battery pack is assembled, lithium battery cells must be top-balanced, if the factory or vendor did not do so before shipment ^[1]. This is an essential step, and should never be skipped. If you have been told differently, or don't believe us, please read [Appendix C](#), where we explain why.

^[1] Overkill Solar 100Ah LiFePO4 cells are shipped top-balanced. If you purchased all cells at the same time, from Overkill Solar, then there you can skip this section.

With that out of the way, it's time to top-balance the battery cells.

Note that this process will take some time. It could take a few days, depending on how many cells you plan on using, and where the state of charge was in each cell before they shipped. Typically cells are shipped at lower than 50% charge, but don't count on this. Assuming your charger or power supply is rated at 10 amps, it will

take five hours per cell. Do not leave the cells unattended during the balancing process. Plan your day accordingly.

1. Obtain a lab CC/CV (constant-current, constant-voltage) regulated power supply capable of providing at least 10 amps.
2. If you already jumped ahead and wired your battery pack up, disconnect everything now (remove the BMS, the bus bars, temp sensor, double-sided tape, everything).
3. Wire all cells in parallel, using the bus bars (all positives wired together, and all negatives wired together). If you do not have enough bus bars, you may use 10-12 AWG cable with crimped ring terminals. Be extremely careful to ensure that all cells are connected together with the proper polarity.
4. Configure the power supply for 3.65V, and set the current to around 1/10 C rate (e.g: For a 100A battery, set the current to 10 amps). Lower currents will work, but will take longer. Higher currents may work, but could affect accuracy, as the discharge curves vary depending on the current draw.
5. If the power supply does not have a voltage readout, then connect a digital multimeter to the positive and negative bus bars. This will need to be monitored throughout the test.
6. If the power supply does not have a current readout (in amps), then connect a digital current meter in series with the circuit, or use a clamp-style meter clamped onto the lead between the supply and the battery (clamp to either positive or negative lead is fine, but not both).
7. Shut the power supply off.
8. Connect the battery positive lead to the power supply positive terminal.
9. Connect the battery negative lead to the power supply negative terminal.
10. Now, turn on the power supply.
11. Wait until the current readout goes to zero. This may take many hours. If the voltage ever exceeds 3.65, stop immediately.
12. At this point, your cells have been top-balanced. Disconnect the power supply leads, and disconnect the bus bars.

WARNING: If the lab power supply polarity is reversed by accident, a tug-of-war between the batteries and the power supply will ensue. The batteries will win, and the power supply will likely be permanently damaged. Use caution.



Figure 2.3.1: Top-balancing cells in parallel (power supply connection not shown)

2.4 Assembly

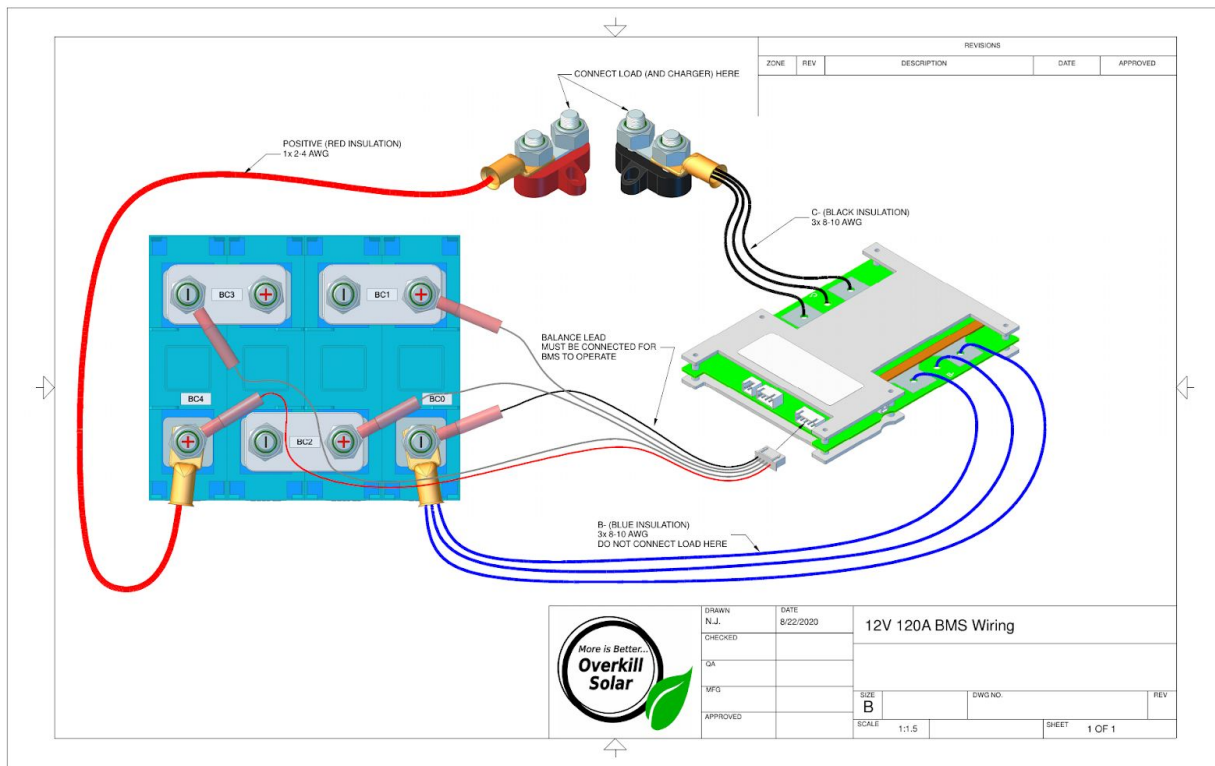

2.4.1 Arranging the Cells

Lay out your cells in the correct orientation. Do not install the bus bars yet.

NOTE: In this section, the 12V 4-cell and 24V 8-cell configurations are shown. Other configurations are covered in [Appendix A](#).

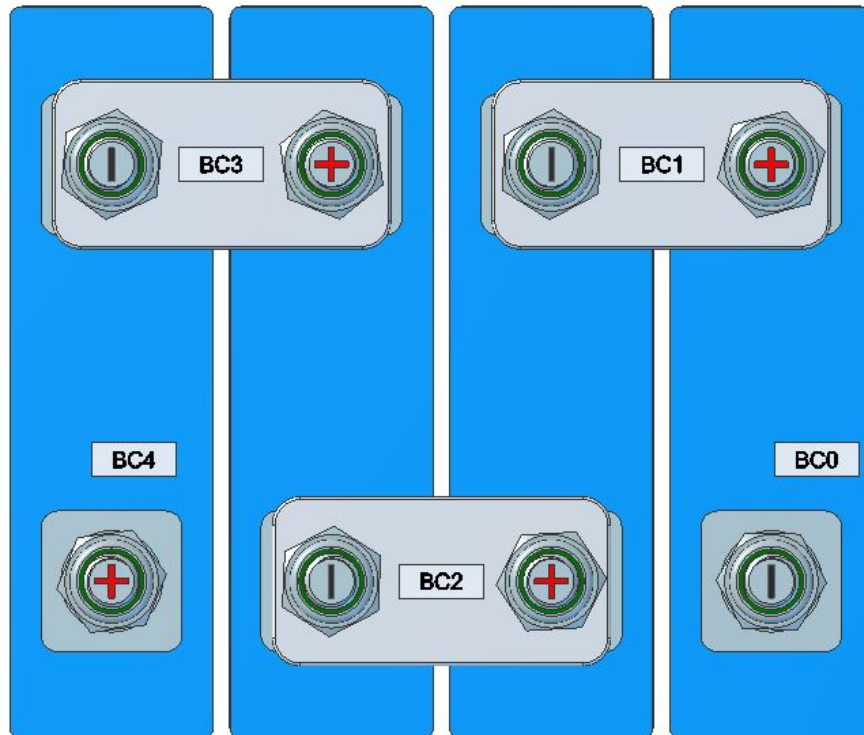

Figure 2.4.1.1: 12V 4-cell battery configuration, top-down view

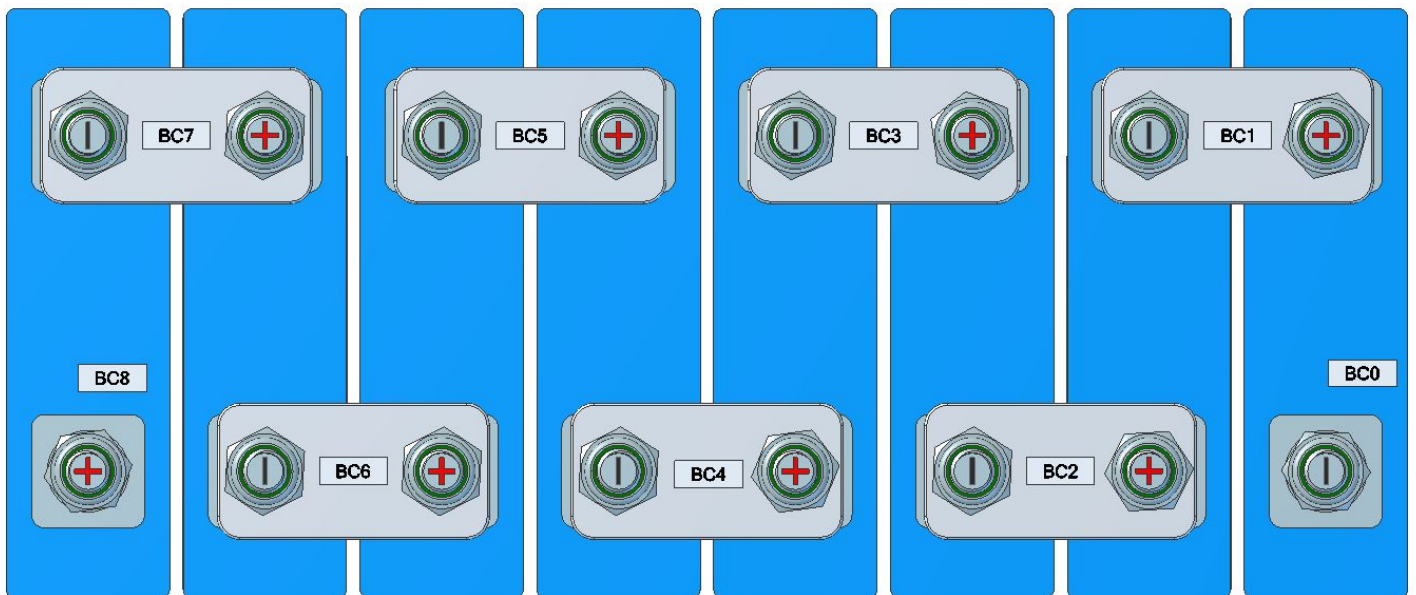

Figure 2.4.1.2: 24V 8-cell battery configuration, top-down view

Use a felt-tip pen (or a label maker) to label each cell, and each terminal on the battery. This will reduce the risk of making mistakes when connecting and reconnecting things. Also, some batteries do not label the + and - terminals very well. Consider using a red marker or red fingernail polish to mark the red terminal (being careful not to get any on the threads or lug contact area).

At this time, mount the cells together. There are many ways to do this. The simplest option is to wrap tape around the cells (gaffer tape is a great choice). Double-sided foam tape between cells is also a good choice. If

using the optional steel frame, mount the cells in it now. If using a fully-enclosed box, it is recommended to get the components wired together and working first, and mount it inside the enclosure last.

Add the bus bars, but don't add the nuts or fasteners yet (balance leads go on before the nuts).

WARNING: This step is critical! Placing a bus bar in the wrong position will cause a short circuit between 2 cells.

2.4.2 Connect the Balance Wires

The balance wire harness should be unplugged from your BMS for now.

The first step is to crimp ring terminals. Prepare the wire ends by cutting the tinned ends off (terminals must be crimped to bare, stranded wire). Strip the ends back. If using 16-22 AWG ring terminals (the red ones), then strip about 3/8" of insulation off, and fold the exposed wire in half in order to double the cross-sectional area. This will allow us to safely crimp a 26 AWG wire inside of the terminal, with less chance of the wire pulling out. Crimp the wire into the terminal using a ratcheting insulated terminal crimper. Then, do a pull-test on the wire. Pull hard, and if the terminal comes off, repeat the process with a new terminal until it's secure.

Start with the black balance wire on BC0. Connect it to the negative-most terminal. Next, find the white wire next to the black wire. This is BC1. The next wire is BC2, and so on. Install each per the diagram.

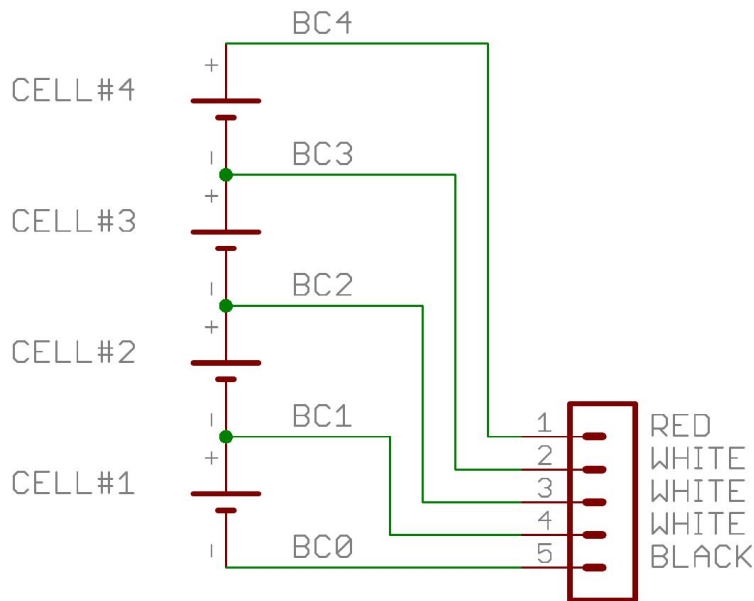

Figure 2.4.2.1: Balance lead connector and pinout, for 12V BMS

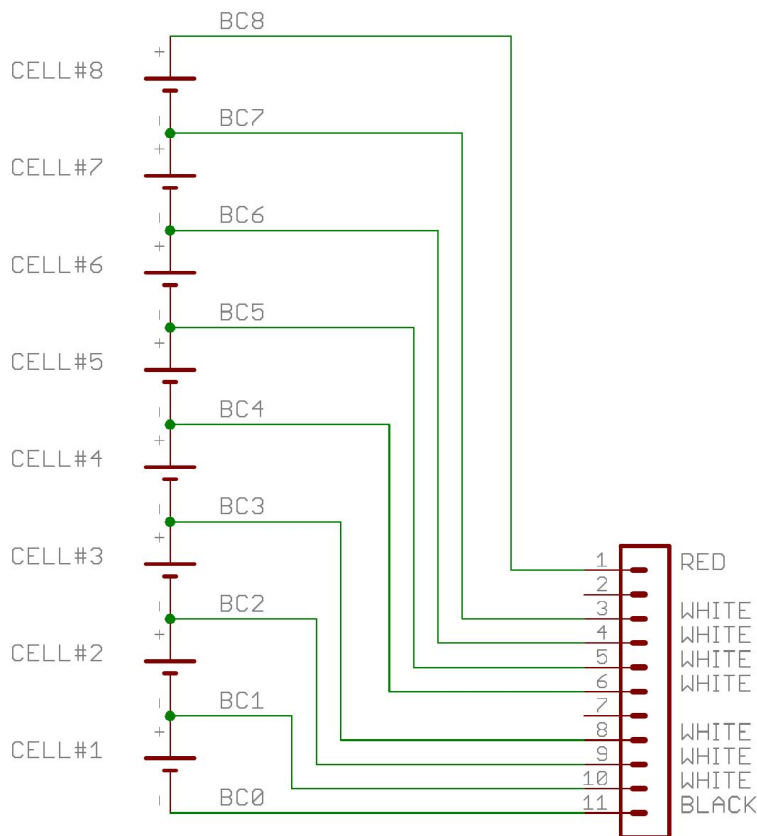

Figure 2.4.2.2: Balance lead connector and pinout, for 24V BMS

Spin the nuts on as you go. Suggest torque is 20 ft-lbs (27 Nm), or “Nice and snug.”

Warning: Do not pinch the balance wires under a nut! Instant smoke!

2.4.3 Prepare BMS

Place the BMS in its desired location. Ideally, it should be mounted vertically, either attached to the battery cells, or mounted as close to them as possible. Ensure that it is mounted within reach of Cell #1’s negative terminal (it should be labeled BC0).

If the B- wires do not reach the BC0 terminal, then they must either be lengthened, or replaced with a longer cable. Longer, thicker pigtail cables are optional at the time of purchase.

2.4.3 Add BMS

Mount the BMS to the pack. Double-sided foam tape and/or zip ties can be used. Wire the BMS’s blue B- pigtail cable to the Cell #1 BC0 terminal. Wire BMS’s C- terminal to the load’s negative connection (or, more ideally, through a power distribution block as described in [Section 2.2.1](#))

2.4.4 Positive Load Connection

Connect the positive-most connection on the battery to the load’s positive connection (or, more ideally, through a power distribution block as described in [Section 2.2.1](#)).

2.4.5 Temperature Sensor



The temperature sensor serves one purpose, and that's to prolong the life of your battery cells when the temperature is too high or too low. Recall that lithium batteries do not work well at temperature extremes. This BMS is capable of protecting the battery cells in four different scenarios (each have their own trigger and release temperatures, and delay times):

1. At extremely low temperatures, prevent charging
2. At extremely low temperatures, prevent discharging
3. At extremely high temperatures, prevent charging
4. At extremely high temperatures, prevent discharging

The thing to stress here is that the BMS must react to the cell temperature, not the temperature of the ambient air. So the temperature sensor must be taped to the cells.

Here are some guidelines to follow:

- Tape the temperature sensor to the battery cell case.
- Do not tape the sensor to the plastic bits that may be on the top side of the battery.
- Placing the sensor between cells in the middle of the pack is better than placing it at the top or bottom of the pack.
- Use Kapton tape if you have it, or can get it. Otherwise, any tape will do, (just make sure that it stays adhered to the battery over the weeks, months, and years to come).

At this point, plug in the temperature sensor, if it was previously disconnected. Tape the sensor to the battery, using the precautions listed above.

2.4.6 External Switch

An optional external switch can be wired to the BMS via the included 2-pin pigtail (JST-XH, red/black wires). If the configuration option is enabled within the BMS, discharging will be disabled when the switch contact is open. When the switch is closed (or a jumper is in the place of the 2-pin connector), the BMS will operate normally.

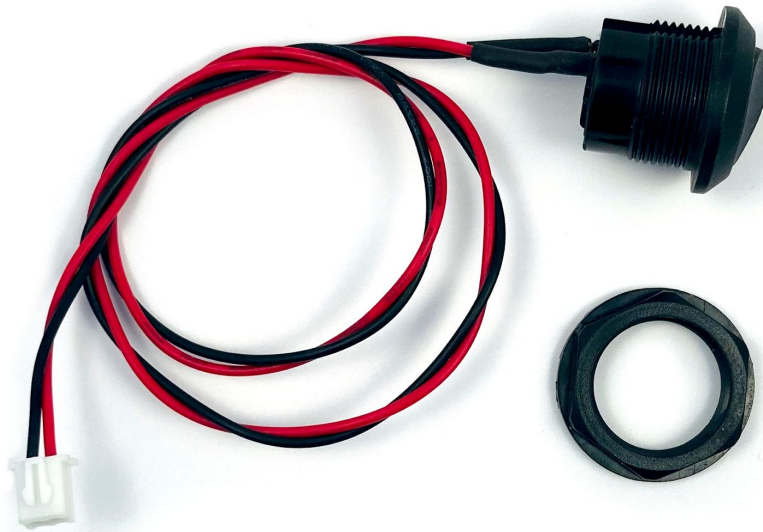

Figure 2.4.6.1, diagram of a switch wired to the pigtail lead

Any switch will do here, as long as it's not momentary. Toggle switches or rocker switches are recommended. When soldering your switch to the lead, use heat-shrink tubing over the connections.

If you do not wish to use the external switch, you may either leave the included jumper in place, or configure the BMS to not use the switch (see [Section 3.4.1](#) for instructions).

2.4.7 Connectivity

For systems with multiple BMSs and battery packs, it may be desirable to use an external battery monitor to visualize the complete system as a single unit.

2.4.7.1 Bluetooth Module

The Bluetooth module is an optional accessory that may be used to configure and monitor the BMS. See [Appendix E](#) for instructions on using the iPhone or Android app.

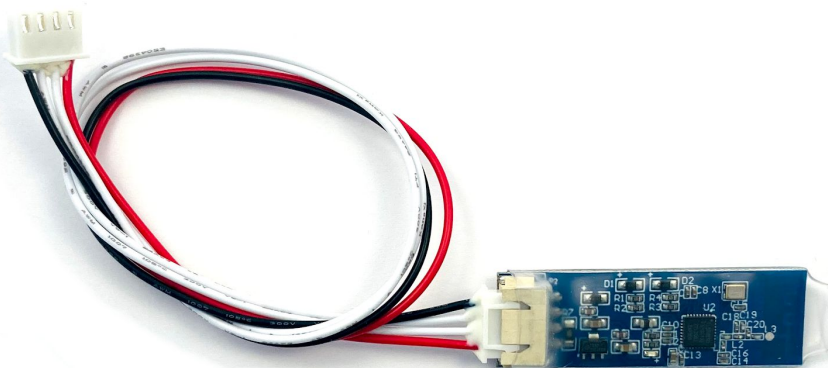

To use, simply plug the 4-pin connector into the BMS. The BMS must be connected to the battery, with the balance lead connected in order for the Bluetooth module to operate.

Note that other Bluetooth modules are not compatible. For best reception, mount the module high, ideally away from metal. Do not mount it inside of a metal enclosure. The Bluetooth module may be left connected to the BMS for long periods of time. It will go into a deep sleep mode when not in use.

2.4.7.1 USB Interface

The USB interface is an optional accessory that may be used to interface the BMS to a personal computer, or an embedded single-board computer (e.g. Raspberry Pi).



The following applications are known to support the USB interface:

App Name	Author	Platform	Link
JBDTools	JBD / XiaoXang	Windows	JBDTools_V1.B-20180820.zip
TBD	Overkill Solar	Windows, Mac, Linux, Raspberry Pi	Anticipated to be released by end of Q4 2020

Before plugging in the USB interface, install the applicable software (see table above). Do not run the software just yet.

A virtual-COM port driver must be installed before the USB interface is plugged into the host computer. The drivers can be found here:

- **Windows:** FTDI VCP drivers come pre-installed on recent versions of Windows. If not, the drivers may be downloaded here: [CDM21228_Setup.zip](#)
- **OS X:** [FTDIUSBSerialDriver_v2_4_4.dmg](#)
- **Linux:** All Modern Linux kernels support the FTDI FT232RL out-of-the-box. No driver download is necessary.

Once the driver has installed successfully, the USB interface can be connected. Plug the 4-pin connector into the BMS. The BMS must be connected to the battery, with the balance lead connected in order for the USB module to operate. Plug the included USB cable to the other side of the black plastic JBD-UART-TOOLS case.

Then plug the other end of the USB cable to the computer. At this point, the computer should detect and recognize the device as a virtual serial COM port. The application may now be started.

Instructions for using the application are covered in [Appendix E](#).

Note that the USB interface does not consume any power from the BMS. It is powered from the USB port. Therefore, leaving the USB interface plugged into the BMS for long periods of time will not drain the battery.

2.4.7.3 Arduino LCD Display

For the adventurous DIYer, we've written an Arduino library that is capable of displaying the following parameters on a 20x4 character LCD screen: Voltage, current, power, capacity, state-of-charge, cycle count, discharge/charge MOSFET status, protection status, individual cell voltages, temperatures, and more. The construction and usage is beyond the scope of this instruction manual, but the [library can be found here](#), and the [documentation can be found here](#).

3. BMS Parameters

3.1 Protection Parameters

3.1.1 Cell over voltage

Disconnects charging current if any cell voltage goes over the Trigger value.
Reconnects when all cells drop below the Release value.

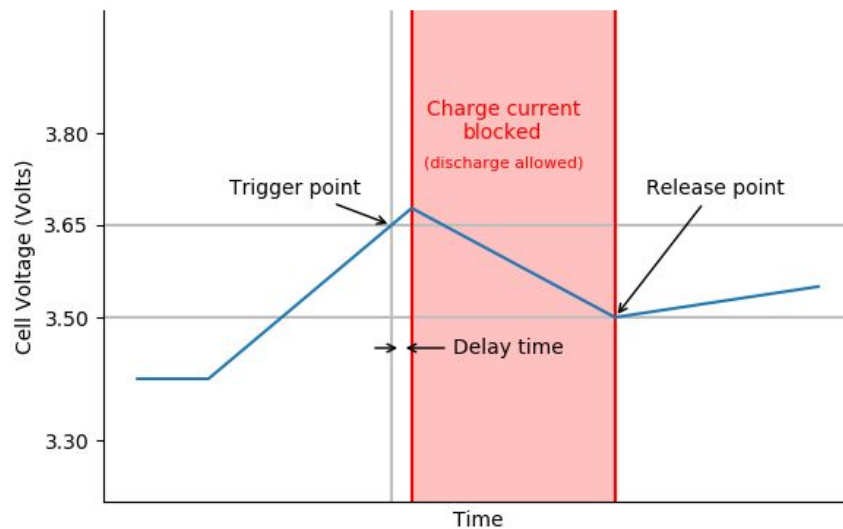

Cell Over-Voltage Protection

3.1.2 Cell under voltage

Cuts off discharging current if any cell voltage goes under the Trigger value.
Reconnects when all cells rise above the Release value.

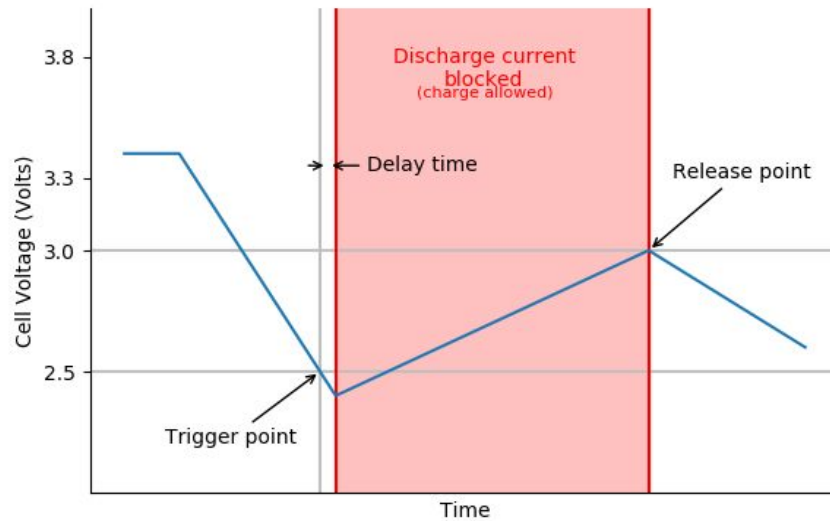

Cell Under-Voltage Protection

3.1.3 Battery over voltage

Cuts off charging current if entire pack goes over the Trigger value.
Reconnects when pack drops below the Release value.

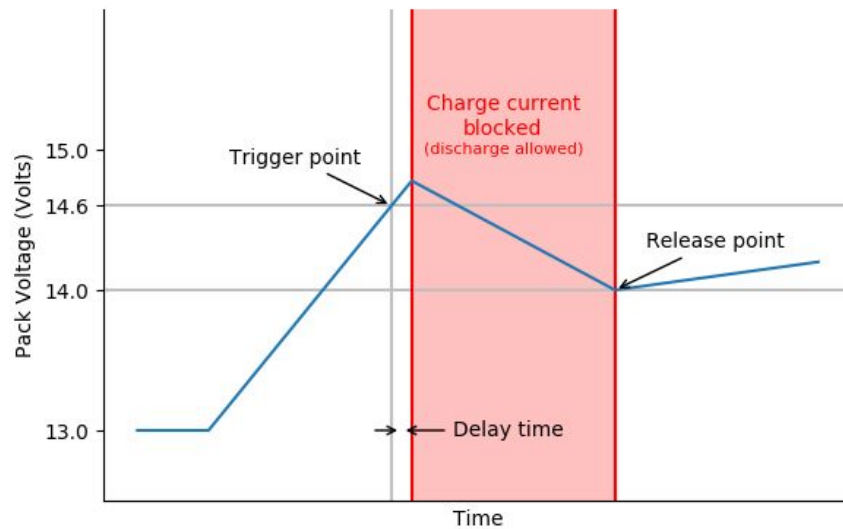

Battery Pack Over-Voltage Protection

3.1.4 Battery under voltage

Cuts off discharging current if entire pack falls under the Trigger value.
Reconnects when pack rises above the Release value.

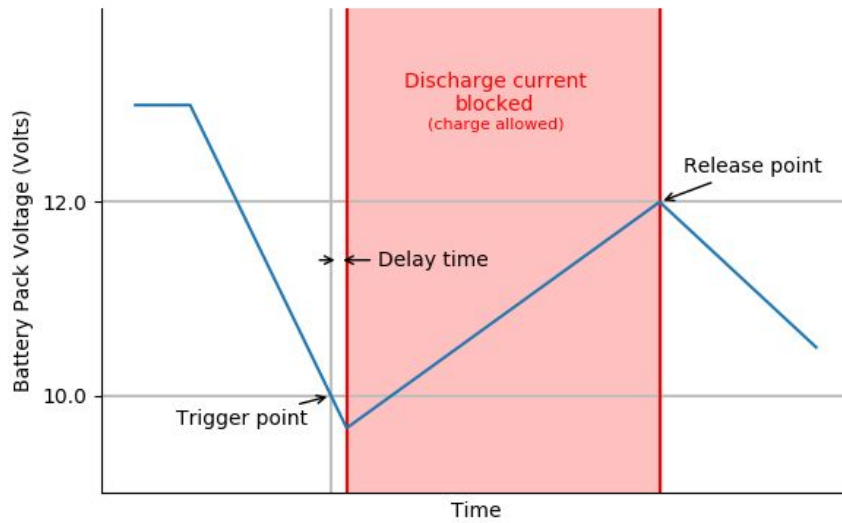

Battery Pack Under-Voltage Protection

3.1.5 Charge over current

Cuts off charging current if the current exceeds the trigger value, for [delay] seconds.
Reconnects after [release value] seconds.

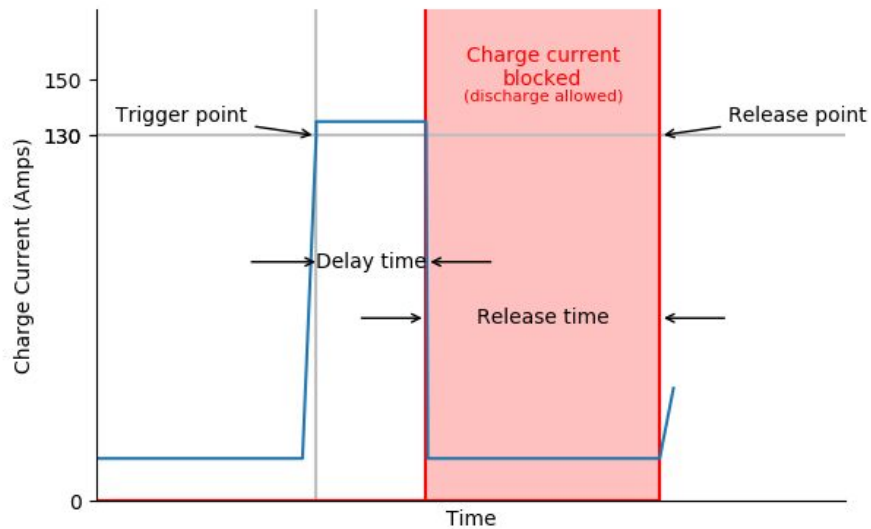

Charge Over-Current Protection

3.1.6 Discharge over current

Cuts off discharging current if the current exceeds the trigger value, for [delay] seconds.
Reconnects after [release value] seconds.

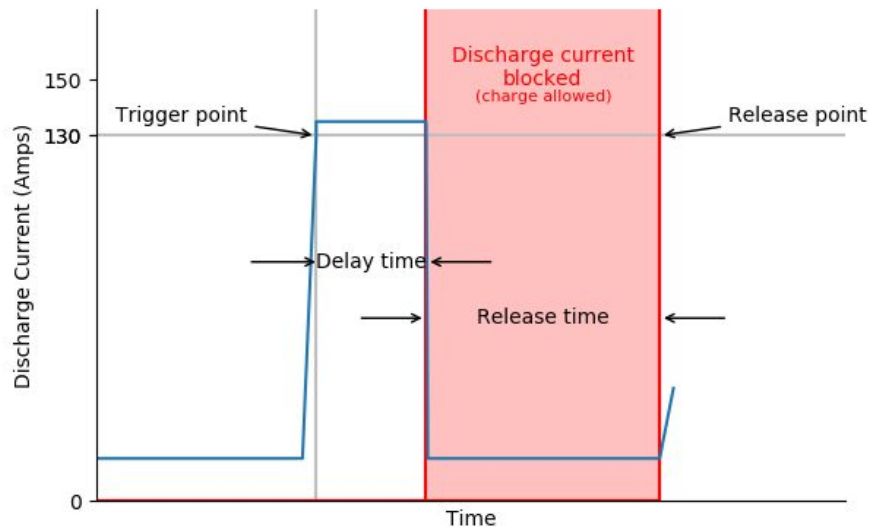

Discharge Over-Current Protection

3.1.7 Charge over temperature

Cuts off charging current if the probe temperature exceeds the trigger value.
Reconnects after the temp drops below the release value.

3.1.8 Charge under temperature

Cuts off charging current if the probe temp drops below the trigger value.
Reconnects after the probe temp rises above the release value.

3.1.9 Discharge over temperature

Cuts off discharging current if the probe temperature exceeds the trigger value.
Reconnects after the temp drops below the release value.

3.1.10 Discharge under temperature

Cuts off discharging current if the probe temp drops below the trigger value.
Reconnects after the probe temp rises above the release value.

3.2 Capacity Parameters

These parameters are used to display the battery capacity and to calculate the state of charge..

3.2.1 Designed Capacity

This should be set to the battery pack's capacity, in amp hours (Ah). It is not used to calculate the state of charge. It's simply used when displaying the intended capacity of the cells. The actual capacity of the pack is defined as the cycle capacity, which is described in the next section. Designed capacity can be calculated as follows:

$$\text{Designed capacity} = \text{Cell capacity} \times \text{Parallel cell count of pack}$$

NOTE: This parameter is displayed in milliamp hours in the iPhone app.

3.2.2 Cycle Capacity

This parameter is used to calculate state of charge. In the real world, batteries do not meet the designed capacity printed on the cells. It can be higher, if the cell was underrated, or it can be lower (especially true for used or B- or C-grade cells).

Ideally, the capacity of the battery pack should be measured, and the actual number should be programmed into the BMS. Therefore:

$$\text{Cycle capacity} = \text{Actual measured capacity of the pack}$$

There are several ways to measure the pack's total capacity. The easiest way is to set the cycle capacity to hook a known DC load up to the battery, and measure the amount of time it takes from full charge down to cutoff. Ensure that the protection parameters are set before starting. Charge up to 100% (see the section on top-balancing). Note the start time. Record the pack voltage in 15 minute intervals (this info may be used to set the percent capacity voltages, later in this section). Record the time when the BMS protection circuitry cuts off the discharge current.

$$\text{Cycle capacity} = \text{Test load current (A)} \times \text{Total run time (h)}$$

NOTE: This parameter only affects the state of charge. If it is set too low, the state of charge will hit zero percent before the battery is actually at zero percent. The state of charge percentage will never go negative.

3.2.3 Full Charge Voltage

This should be set to the cell's voltage at full charge. This information typically comes from the battery cell's datasheet, but the recommended values in Appendix A may be used.

3.2.4 End of Discharge Voltage

This should be set to the cell's voltage and end of discharge. This information typically comes from the battery cell's datasheet, but the recommended values in Appendix A may be used.

3.2.5 Discharge Rate

Leave this at the default setting.

3.2.6 80%, 60%, 40%, 20% Capacity Voltage Levels

This should be set to the cell's voltage at each of the four indicated state of charge levels. This information typically comes from the battery cell's datasheet, which may involve interpreting the discharge curve graph. However, the recommended values in Appendix A may be used.

3.3 Balance Parameters

3.3.1 Start Voltage

The BMS will not begin its balancing routine until the cell voltage(s) are above this voltage. Typically this parameter should be set towards the top of the battery's voltage curve.

3.3.2 Delta to balance

The BMS will not balance unless the delta exceeds this level. Setting this value too coarse will result in possible cell damage; setting this value too fine will result in the BMS dissipating considerable heat as it attempts to equalize the cell voltages. Recall that the passive balancing circuit works by routing the excess voltage into resistors within the BMS, which converts into heat. This value must be a compromise between those two extremes. Please see the recommended values in Appendix A.

3.3.3 Balancer Enabled

The BMS will only perform its balancing routine if this option is enabled.

There are very few reasons why this would ever be turned off. We recommend to keep it enabled.

3.3.4 Balance only when Charging

When enabled, the balancing routine will only be performed when charging.

When disabled, the BMS will enter Static Balance mode, where it will balance when both charging and discharging.

NOTE: Charging while balancing is usually more effective, because the cell delta is greatest at the top of the charge. We recommend to keep this setting enabled.

3.4 Other Parameters / Features

3.4.1 Switch

When enabled, the discharge FET will be disabled when the optional external switch contact is open. This external switch, if used, must be wired to the 2-pin JST-XH connector on the BMS (see Appendix D1.3).

When disabled, the external switch will not be monitored or read.

3.4.2 Load Detect

When enabled, you will need to disconnect the load after a short-circuit before the battery pack can be used again.

3.4.3 LED Enabled

Not applicable. Our BMS does not have the LED populated.

3.4.4 LED Capacity

Not applicable. Our BMS does not have the LED populated.

On BMS modules that have an LED, this would blink the capacity out (e.g., 5 blinks would mean 100% capacity).

3.4.5 BMS Name

Not applicable; has no effect on the behavior of the BMS. However, if the PIN protect option is used within the iPhone app, it will use the name as a PIN passcode, which could leave you locked out of your BMS. We recommend to leave this alone, and to not use the iPhone app's PIN protect function.

3.4.6 Barcode

Not applicable. This does not affect the operation of the BMS. We recommend to keep it at its default value.

3.4.7 NTC Settings

Leave these at their default setting.

12V BMS:

NTC1 NTC2 NTC3 NTC4 NTC5 NTC6 NTC7 NTC8

24V BMS:

NTC1 NTC2 NTC3 NTC4 NTC5 NTC6 NTC7 NTC8

4. Periodic Maintenance

4.1 Periodic Cable Check

Periodically perform a cable check:

1. Ensure that the cables have not loosened. Use a wrench or socket to tighten any connections or terminals that have come loose.
2. Ensure that no wires have pinched or frayed; especially the balance wires.

4.2. Periodic Voltage Check

If the battery pack has gone unused for more than 6-12 months, it is recommended to check the cell voltages with a multimeter. If they are low, charge the battery pack until the voltages are around 50-80%.

Use the iPhone / Android app and the bluetooth module to ensure that the cell voltages are not different by more than XXXX millivolts when fully charged. If the cells are off by more than a few millivolts, first verify with an external voltmeter. If the voltmeter doesn't agree, then the BMS may need calibration (follow the steps in [Section 4](#)). Otherwise, a top-balance might be necessary to bring them closer together. See [Section 2.3](#) for the top-balancing procedure.

5. Troubleshooting & FAQ

Q: Why is this so complicated?

A: Because it is. This equipment was not designed to be a consumer item or DIY project, but here we are. Lithium batteries demand this level of control.

Q: I have a charge under-temperature warning. The sensor says -30 degrees Celsius?

A: Make sure that your temperature sensor is plugged in. An open-circuit temperature probe always reads as -30c. If your probe is damaged you can set the under-temperature protection parameter to -40. This will allow the BMS to operate until a new probe can be obtained.

Q: I don't understand the wiring diagram. Why is the negative terminal the way it is?

A: This is a common question. The BMS is a glorified high-current automatic switch. It needs to be in series with the battery somewhere in order to interrupt the current when it senses an issue with voltage, current, or temperature. Your load (and charger(s)) must therefore be placed after the BMS in the circuit.

Q: What is the quiescent current? What can I do for long-term storage?

A: The quiescent current is as follows:

- 5.5 milliamps with everything off, when the BMS is active, but no bluetooth.
- 15 milliamps with the bluetooth active (after about 10 seconds it drops to 0.8 milliamps. Reconnecting it wakes it up again).
- 0.8 milliamps when the BMS is inactive.

So, assuming your battery setup is 100 amp hours, the BMS would run for 17 years. This proves that the BMS can be connected for long periods of time without any fear of it draining the battery.

Unplugging the balance connector would ensure complete shutdown

NOTE: The cell's self-discharge rate will always cause the battery to drain over time, which may be several percent per month. This is simple chemistry and physics; there's nothing that you or the BMS can do to avoid the battery cells from self-discharging over time, other than to occasionally top up the batteries.

Q: I can't get the bluetooth paired to my phone. Help!

A: In all cases, the bluetooth module should be selected from the monitoring app. NOT paired with the phone or tablet device.

Q: My Android device says "Pairing Rejected". What does that mean?

A: This can be resolved by setting the device's location sensitivity to "High". Also, make sure GPS location is enabled.

Q: Why?

A: I don't know, I use an iPhone.

Q: OK but why?

A: Android 5 and later requires access permission to the (coarse) location services. Otherwise it cannot scan for bluetooth products. Besides permitting access, the location services may also need to be enabled. Note that after enabling location services, the GPS can be switched off. Please be aware that this is a Google Android phone quirk. The BMS does not require this information to work; nor does Overkill Solar care what

your location is. Google's excuse is that they are no longer using MAC addresses as identifiers between devices, and that they now use GPS. Which is probably BS. It's probably an excuse to collect more location info which they store in their giant database. But there's not much that can be done about it.

Q: One of my cells is reading high, and one of my cells is reading low.

A: If one cell is reading very high and another cell is reading very low, the balance leads are connected in the wrong order, or not connected at all. Check the order and check the connections. Pinching the insulation in the crimp connector can have this effect also.

Q: What does the optional switch do?

A: This connection allows a remote switch to disable discharging of the battery pack. Charging is unaffected. Useful as a remote battery shut-off switch. Connect only to an isolated switch contact. This feature can also be disabled in software.

Q: I don't have a bluetooth module. Where can I buy it?

A: Buy it from <https://overkillsolar.com/product/bluetooth-module/>

Q: Can I use any Bluetooth module? Or must I use the model linked above?

A: We have tried several off-the-shelf Bluetooth modules, and none of them have worked. We can only recommend and support the official Bluetooth module linked above.

Q: Should I balance while charging or discharging?

A: Charging while balancing is usually more effective, because the cell delta is greatest at the top of the charge.

This is labelled confusingly in the iOS app. Our recommendation is to leave it to the default value of "Bal. only when charging" = enabled.

Q: Can I parallel / Series?

A: Complete assemblies can be connected in parallel or series. Imagine the battery and BMS in a black box with only the positive and negative terminals exposed, like a lead acid or battleborn.

Q: What about fuses?

A: The BMS itself is a solid state circuit breaker that protects the battery cells. Fuses and/or circuit breakers should be used and sized as appropriate to protect your wire size outside the battery pack

Q: My battery pack depleted to the point of under-voltage cutoff. And now I can't charge from solar, because my MPPT controller is powered from the battery pack, which is in undervoltage protection cutoff. How do I recover from this?

A: There are three methods to recover from this catch-22 scenario:

But first, turn off all loads (inverters, lights, etc) because we need to revive the battery to the point where the under-voltage cutoff protection releases. This can be several volts above the point where the cutoff occurred (refer to [Section 3.1.2](#) and [Section 3.1.4](#) for a description of the two applicable protection modes, and refer to Appendix A for recommended values.

The first method is to simply charge the battery pack using an AC-DC charger on shore power. The AC-DC charger will have no problem charging the battery, whereas the solar MPPT will only charge if the battery isn't

in discharge protection mode. If you don't have access to shore power, then use either the second or the third method below.

The second method is to "jump-start" the battery pack with another battery, which can be a lead-acid car or deep-cycle battery (if you've got a large-capacity lithium battery laying around, that would work too, but lead acid batteries are more common). Just ensure that the voltage of the jump-start battery has the same nominal voltage as the battery pack in need of the charge.

The third method is a bit more clever, and doesn't require lugging a battery around. You can do it from your smartphone, if you have the optional Bluetooth module. Pull up the BMS configuration app (XiaoxiangBMS on iPhone). Go into the protection parameter settings page. Write down the undervoltage protection numbers or take a screenshot of them. **Temporarily** lower the cell undervoltage release value. For example, for LiFePO4, lower it from 3000 to 2800). This will allow the discharge FET to activate (remember we disabled all loads, so the only thing that should be allowed to discharge is the MPPT controller). This should give the MPPT charge controller power, which will start charging your battery pack, assuming that the cells are in full sunlight. Wait until the batteries have recovered a bit of charge, and then go back into the BMS configuration app, and return the undervoltage parameters to their original value.

Q: Why doesn't it charge high enough?

A: The BMS does not control the charge voltage. This needs to be configured in the settings of your charger.

Q: Can I use a lead-acid charger to charge a LiFePO4 battery pack? Or do I need one that supports LiFePO4?

A: Well that's a deep subject.

"a lead acid charger" can be a lot of different things.
smart, dumb, adjustable/programmable....

Short answer is yes, the battery will tolerate it.

Long answer, possible failures:

- Some won't charge to a high enough voltage.
- Some will be overloaded by the low internal resistance of the battery(similarly to alternators.)
- Some will charge too high if they do an equalization cycle.
- Dumb unregulated chargers will charge too high.

Charging too high could damage connected equipment. Because this is a common port BMS, everything in the system is connected together. When the BMS disconnects for overvoltage, the charger is still active and connected to the rest of the system, possibly resulting in a damaging unregulated voltage spike.

We suggest only using regulated chargers and/or power supplies. Set the upper voltage limit to 14-14.4v

If the charger only offers battery profiles, choose the setting for AGM batteries.

A lab CC/CV (constant-current, constant-voltage) power supply also makes a good charger. Set CV to 14-14.4v

If there are absolutely no other options but a dumb charger, connect a healthy lead acid battery in parallel with the system. If the lithium pack disconnects, the lead acid battery will continue to regulate the system.

Q: Someone told me that you don't need a BMS.

A: Below on the left is a picture from one of our customers that wasn't using a BMS. It was over-charged, which creates gasses, and can cause the outer case to bulge (this kills the battery). One of the jobs of a BMS is to prevent overcharging. We've also seen batteries that have been discharged down to zero volts, rendering them useless, but the photographs are not as interesting.



Even if you think you can't over-charge because your smart charger stops at 13.8, unbalanced cells can and will over-charge a single-cell, long before the overall pack voltage tops out at 13.8.

In conclusion, *always* use a BMS with lithium batteries.

Q: I fully charged my cells to 3.6 each and overnight they discharged down to 3.4v OMG WTF how am i losing so much power AHHHH

A: This doesn't necessarily indicate self discharge. LiFePO4 chemistry just takes some time to equalize. This is normal.

Q: Someone told me that bottom-balancing is better than top-balancing.

A: Always top-balance. [Will Prowse explains why in this informative video](#). Also, see Appendix C, About Cell Balancing.

6. Technical Support, Return, and Refund Policy

Email OverkillSolar@gmail.com for technical support.

Our BMS policy is quite simple:

If you need help, I will help.

If it isn't working right I will replace it.

If it's totally fried I will refund your money.

This includes anything you did to break it.

Enjoy,

Steve.

Appendix

Appendix A: Recommended Parameters

Recommended parameters for specific battery types are given in [Appendix B](#). General settings are listed below.

A.1 General Settings

Recommended generic settings can be found below. These settings assume LiFePO4 batteries. They can be used as a starting point.

Capacity configuration:

Parameter	Value	Units
Designed capacity	This should be the rated capacity of your battery in milliamps (multiply the amp-hours of your pack by 1000) Examples: 50 Ah pack: 50000 60 Ah pack: 60000 100Ah pack: 100000 200 Ah pack: 200000 280 Ah pack: 280000	mAh
Cycle capacity	This should be roughly 80% of the value above. Examples: 50 Ah pack: 40000 60 Ah pack: 48000 100Ah pack: 80000 200 Ah pack: 160000 280 Ah pack: 224000	mAh
Full charge voltage (per cell)	3500	mV
End of discharge voltage (per cell)	2800	mV
Discharge rate	0.2	%
80% capacity voltage (per cell)	3400	mV
60% capacity voltage (per cell)	3300	mV
40% capacity voltage (per cell)	3200	mV
20% capacity voltage (per cell)	3100	mV

Balance Configuration

- **Balancer start voltage:** 3400 mV

- **Balancer delta-to-balance:** 15 mV
- **Balancer enabled:** True
- **Balance only when charging:** True

Other Parameters / Features:

These settings are consistent across all battery types. For capacity and protection settings, see the individual sections below for your specific battery type.

- **Number of cells:** Leave this at the factory default setting that ships with the BMS.
 - 12V BMS: 4 cells
 - 24V BMS: 8 cells
- **External switch:** Set this to True if you have an external switch wired to the 2-pin connector, as detailed in section 2.2.6.
- **Load Detect:** Enabled
- **LED Enabled:** N/A
- **LED cap.:** N/A
- **NTC Settings:** 12V BMS: The first two NTC's should be enabled. The others are not present, so should be disabled.
 - 24V BMS: The first 3 NTC's should be enabled. The others are not present, so should be disabled.
- **BMS Name / PIN Protect:** N/A; leave this setting to its default value

A.2: 12V Pack, 4 Cell, Using One 12V BMS and 100Ah LiFEPO4 cells

Mechanical Drawing

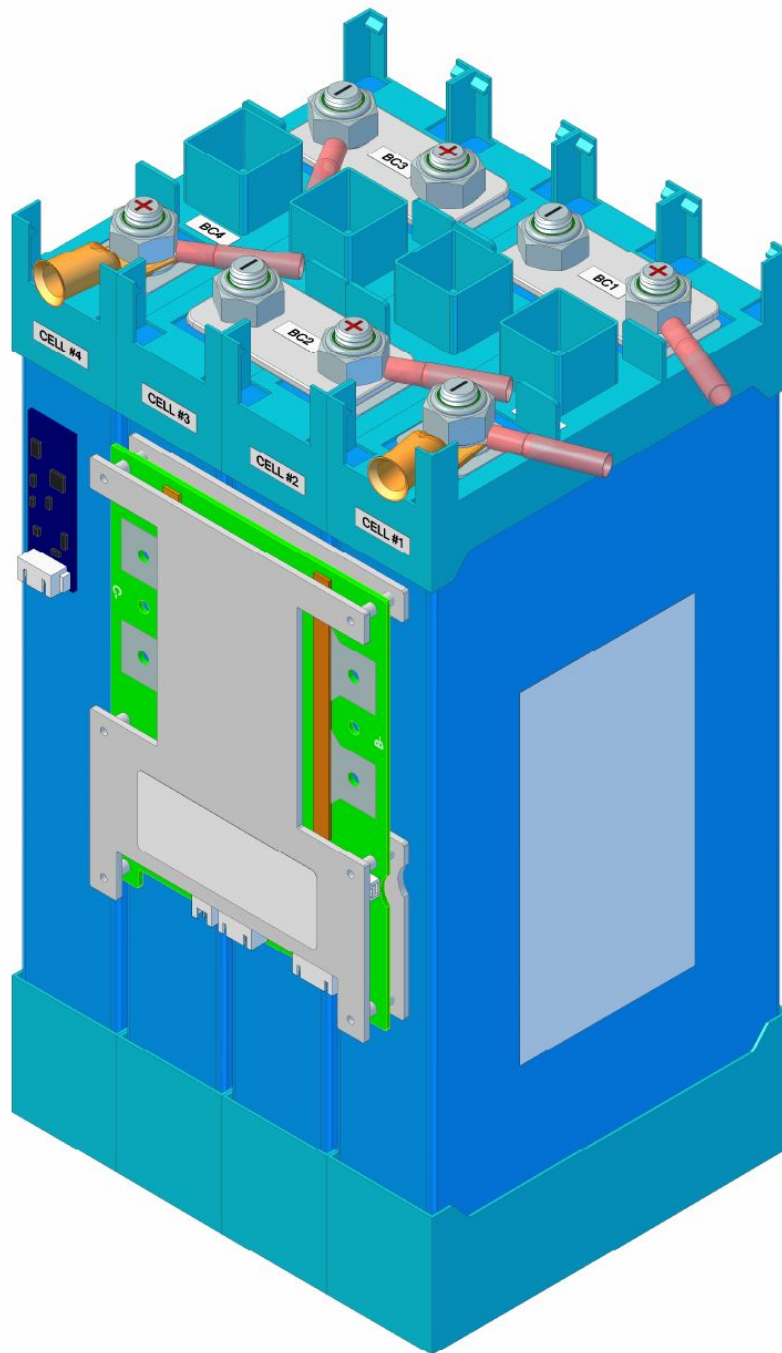

Figure A.2.1: 12V 4-cell pack assembly

Bill of Materials

#	Qty	Description	Notes
1	1	12V BMS	JBD-SP04S020

2	1	BMS balance leads	Included with BMS
3	1	Temperature sensor lead	Included with BMS
4	1	External switch pigtail	Included with BMS. If desired, this will shutoff the discharge FET, preventing battery drain when activated.
5	1	BMS Bluetooth module with cable	Optional accessory for BMS
6	4	Battery cells	100Ah LiFEPO4
7	8	Battery cell nuts for lugs	10mm, nylon locking. Included with Overkill Solar LiFEPO4 cells
8	3	Bus bars	Included with Overkill Solar LiFEPO4 cells
9	1	Power distribution block (positive)	2 or more 3/8" lugs, red. Rated for > 150A
10	1	Power distribution block (negative)	2 or more 3/8" lugs, black. Rated for > 150A
11	1	Wire, positive lead, red (current-carrying cable between last battery cell positive and the power distribution block)	4 AWG minimum. 2 AWG recommended. Red insulation.
12	2	Ring terminals, positive lead	4 AWG minimum. 2 AWG recommended. 3/8" inside diameter.
13	2	Ring terminals, BMS pigtails	For standard 10 AWG pigtails: 6 AWG, 3/8" ID (NOTE: these can be optionally included with the BMS at order time) For optional 8 AWG pigtails: 4 AWG, 3/8" ID
14	5	Ring terminals, balancing lead	16-22 AWG, 3/8" ID, insulated Included with Overkill Solar LiFEPO4 cells
15	A/R	Zip tie, light-duty, 6"	For cable management.
16	A/R	Zip tie, heavy-duty > 12"	Optional. May be used to secure BMS to battery pack.

Wiring Diagram

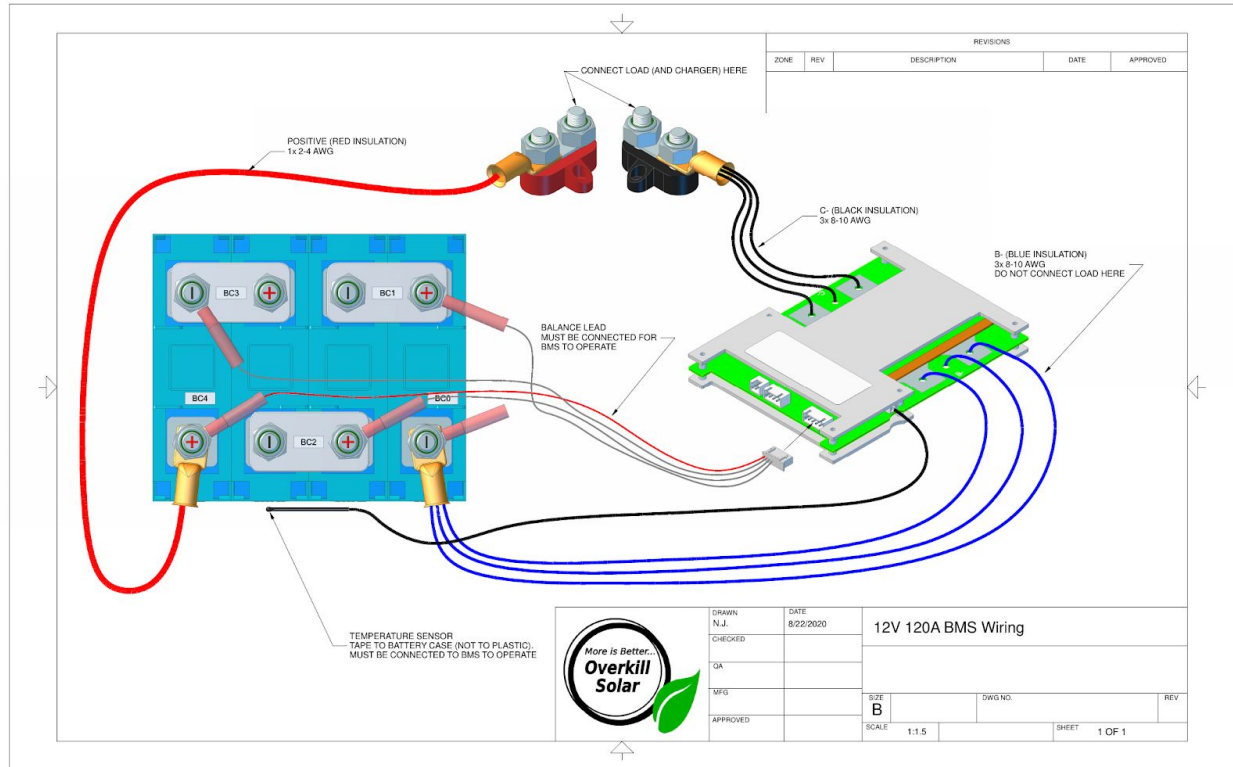

Figure A.2.2: Wiring Diagram for 12V pack, 4-cell using one 12V BMS

BMS Configuration Parameters

Capacity configuration:

Parameter	Value	Units
Designed capacity	100000 (100 amp hours)	mAh
Cycle capacity	80000	mAh
Full charge voltage (per cell)	3500	mV
End of discharge voltage (per cell)	2800	mV
Discharge rate	0.2	%
80% capacity voltage (per cell)	3400	mV
60% capacity voltage (per cell)	3300	mV
40% capacity voltage (per cell)	3200	mV
20% capacity voltage (per cell)	3100	mV

Protection parameters:

Parameter	Trigger Value	Release Value	Delay
-----------	---------------	---------------	-------

			(seconds)
Cell over voltage	3650 mV	3500 mV	2
Cell under voltage	2500 mV	3000 mV	2
Battery over voltage	14600 mV	14000 mV	2
Battery under voltage	10000 mV	12000 mV	2
Charge over current	130000 mA	32s	10
Discharge over current	130000 mA	32s	10
Charge over temp	65°C	55°C	2
Charge under temp	-1°C	5°C	2
Discharge over temp	75°C	70°C	2
Discharge under temp	-10°C	0°C	2

A.3: 12V Pack, 8 Cell, Using One 12V BMS

Mechanical Drawing

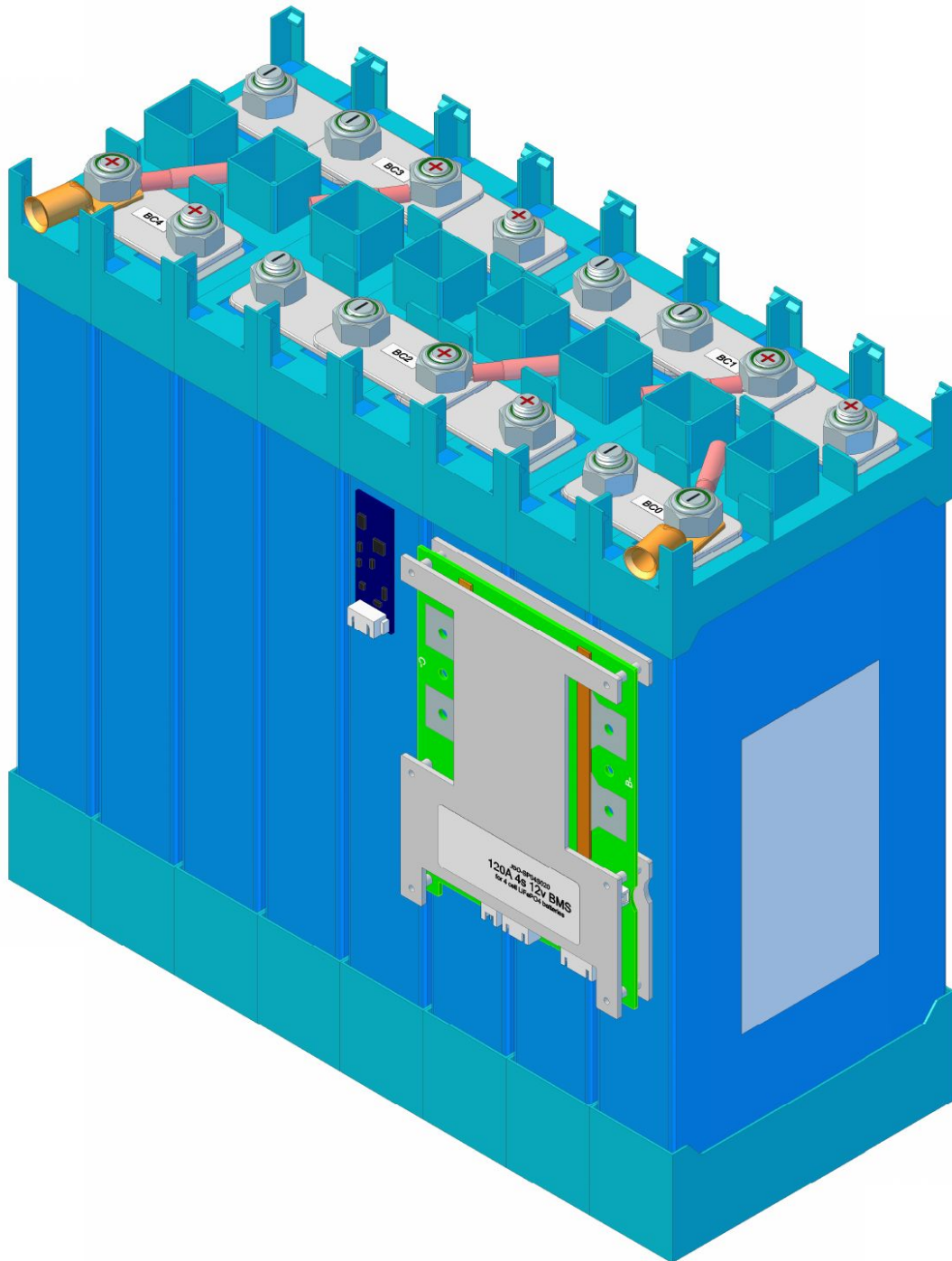

Figure A.3.1: 12V 8-cell pack assembly

Bill of Materials

Wiring Diagram

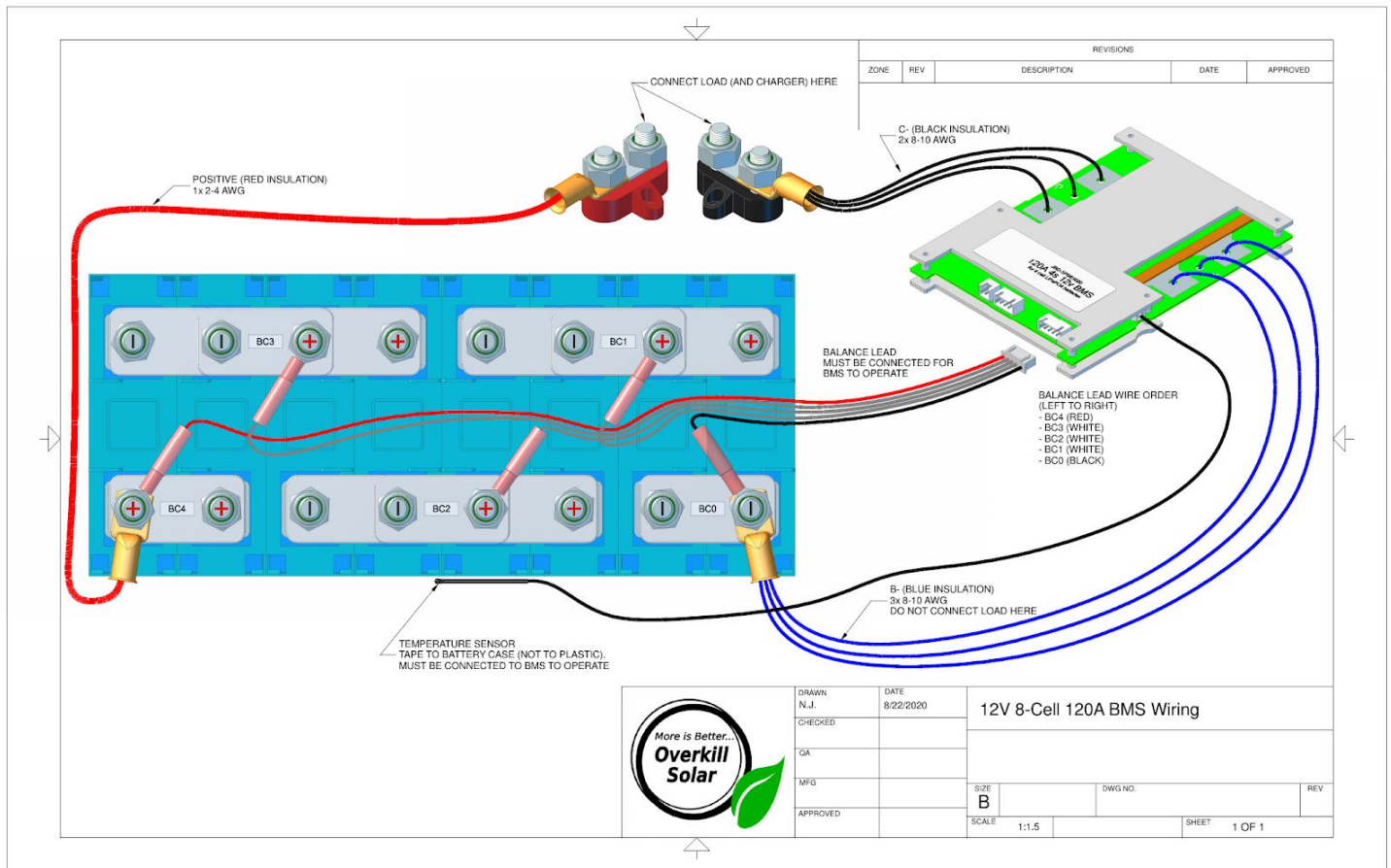

Figure A.3.2: Wiring Diagram for 12V pack, 8-cell using one 12V BMS

BMS Configuration Parameters

Capacity configuration:

Parameter	Value	Units
Designed capacity	200000 (200 amp hours)	mAh
Cycle capacity	160000	mAh
Full charge voltage (per cell)	3500	mV
End of discharge voltage (per cell)	2800	mV
Discharge rate	0.2	%
80% capacity voltage (per cell)	3400	mV
60% capacity voltage (per cell)	3300	mV
40% capacity voltage (per cell)	3200	mV

20% capacity voltage (per cell)	3100	mV
---------------------------------	------	----

Protection parameters:

Parameter	Trigger Value	Release Value	Delay (seconds)
Cell over voltage	3650 mV	3500 mV	2
Cell under voltage	2500 mV	3000 mV	2
Battery over voltage	14600 mV	14000 mV	2
Battery under voltage	10000 mV	12000 mV	2
Charge over current	130000 mA	32s	10
Discharge over current	130000 mA	32s	10
Charge over temp	65°C	55°C	2
Charge under temp	-1°C	5°C	2
Discharge over temp	75°C	70°C	2
Discharge under temp	-10°C	0°C	2

A.4: 24V Pack, 8 Cell, Using One 24V BMS

Mechanical Drawing

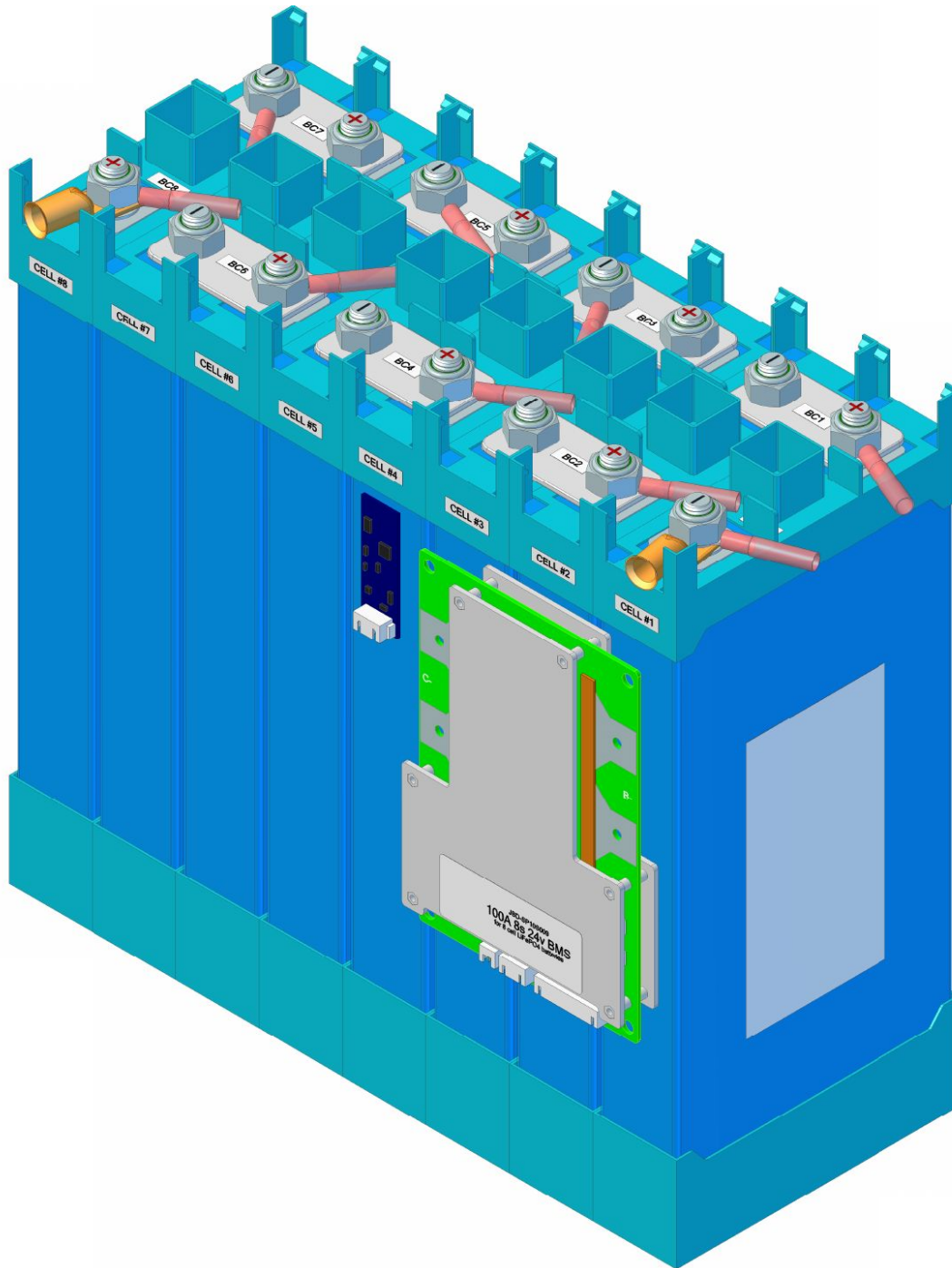

Figure A.4.1: 24V 8-cell pack assembly

Bill of Materials

#	Qty	Description	Notes
1	1	24V BMS	JBD-SP10S009

2	1	BMS balance leads	Included with BMS
3	1	Temperature sensor lead	Included with BMS
4	1	External switch pigtail	Included with BMS. If desired, this will shutoff the discharge FET, preventing battery drain when activated.
5	1	BMS Bluetooth module with cable	Optional accessory for BMS
6	8	Battery cells	100Ah LiFEPO4
7	16	Battery cell nuts for lugs	10mm, nylon locking. Included with Overkill Solar LiFEPO4 cells
8	7	Bus bars	Included with Overkill Solar LiFEPO4 cells
9	1	Power distribution block (positive)	2 or more 3/8" lugs, red. Rated for > 150A
10	1	Power distribution block (negative)	2 or more 3/8" lugs, black. Rated for > 150A
11	1	Wire, positive lead, red (current-carrying cable between last battery cell positive and the power distribution block)	4 AWG minimum. 2 AWG recommended. Red insulation.
12	2	Ring terminals, positive lead	4 AWG minimum. 2 AWG recommended. 3/8" inside diameter.
13	2	Ring terminals, BMS pigtails	For standard 10 AWG pigtails: 8 AWG, 3/8" ID (NOTE: these terminals can be optionally included with the BMS at order time) For optional 8 AWG pigtails: 6 AWG, 3/8" ID
14	5	Ring terminals, balancing lead	16-22 AWG, 3/8" ID, insulated Included with Overkill Solar LiFEPO4 cells
15	A/R	Zip tie, light-duty, 6"	For cable management.
16	A/R	Zip tie, heavy-duty > 12"	Optional. May be used to secure BMS to battery pack.

Wiring Diagram

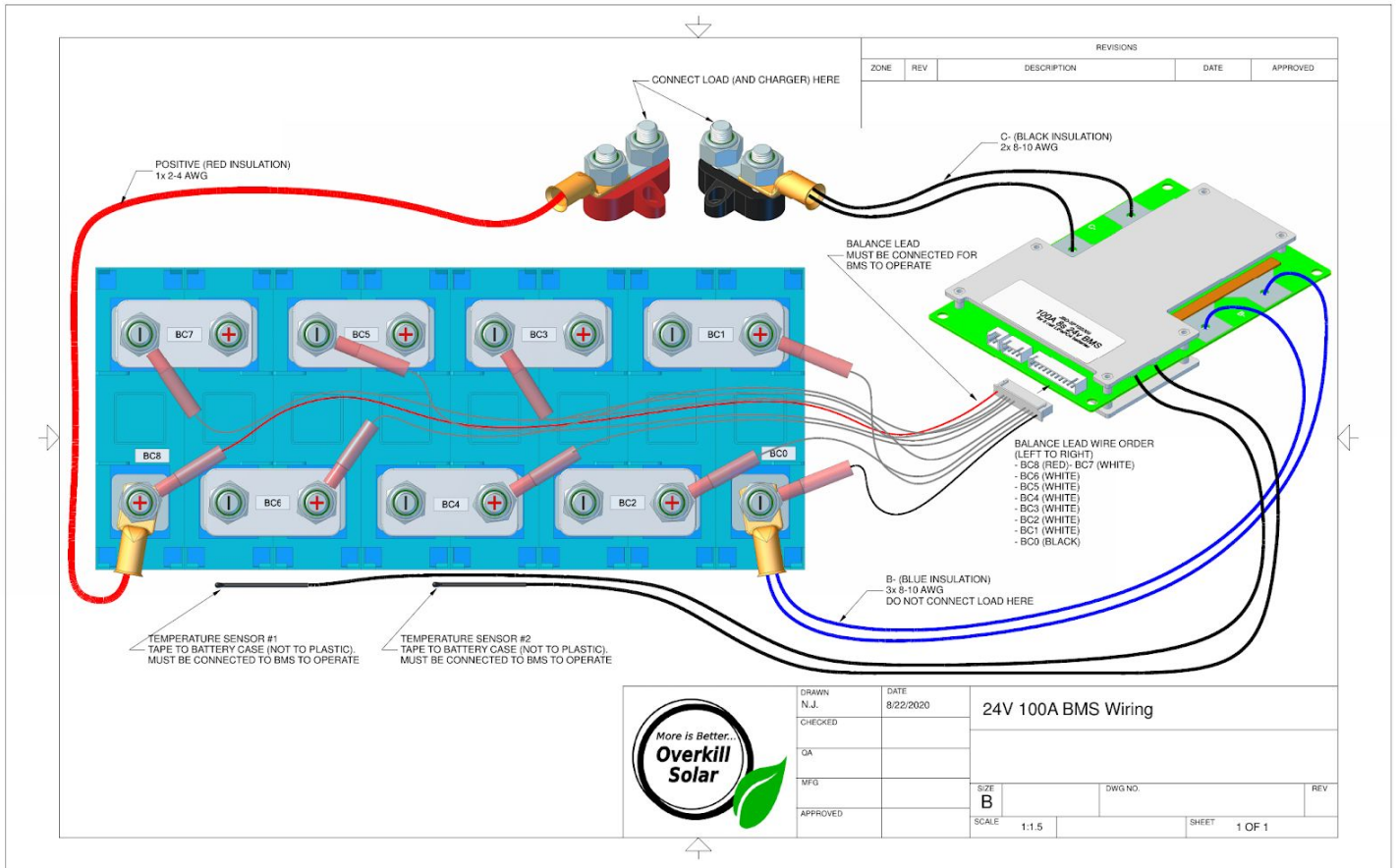

Figure A.4.2: Wiring Diagram for 24V pack, 4-cell using one 12V BMS

BMS Configuration Parameters

Capacity configuration:

Parameter	Value	Units
Designed capacity	This should be the rated capacity of your battery in milliamps (multiply the amp-hours of your pack by 1000) Examples: 50 Ah pack: 50000 60 Ah pack: 60000 100Ah pack: 100000 200 Ah pack: 200000 280 Ah pack: 280000	mAh
Cycle capacity	This should be roughly 80% of the value above. Examples: 50 Ah pack: 40000 60 Ah pack: 48000 100Ah pack: 80000 200 Ah pack: 160000	mAh

	280 Ah pack: 224000	
Full charge voltage (per cell)	3500	mV
End of discharge voltage (per cell)	2800	mV
Discharge rate	0.2	%
80% capacity voltage (per cell)	3400	mV
60% capacity voltage (per cell)	3300	mV
40% capacity voltage (per cell)	3200	mV
20% capacity voltage (per cell)	3100	mV

Protection parameters:

Parameter	Trigger Value	Release Value	Delay (seconds)
Cell over voltage	3650 mV	3500 mV	2
Cell under voltage	2500 mV	3000 mV	2
Battery over voltage	29000 mV	28000 mV	2
Battery under voltage	20000 mV	24000 mV	2
Charge over current	110000 mA	32s	10
Discharge over current	110000 mA	32s	10
Charge over temp	65°C	55°C	2
Charge under temp	-1°C	5°C	2
Discharge over temp	75°C	70°C	2
Discharge under temp	-10°C	0°C	2

A.5: 24V Pack, 16 Cell, Using One 24V BMS

TBD

Mechanical Drawing

Bill of Materials

Wiring Diagram

BMS Configuration Parameters

A.6: 48V Pack, 16 Cell, Using Two 24V BMSs

TBD

Mechanical Drawing

Bill of Materials

Wiring Diagram

BMS Configuration Parameters

Appendix B: Calibration

Your BMS should come calibrated. In certain use-cases, the voltages and currents might be off. In most cases, calibration can fix this. We do not recommend doing this unless your readings are way off. It's possible to damage your BMS or your battery bank if this process is not followed to the letter.

B.1 Voltage Calibration

You will need an accurate voltmeter to perform voltage calibration. Make sure that you trust the readings that it gives. It needs to be accurate to at least 1 millivolt. If you use a cheap or badly-calibrated voltmeter, you will only make your calibration worse. Also, if your meter came with CATIII / CATIV test lead shields, install them. These are typically used when working around high voltage. However they're also handy when working around low-voltage, high-current. There will be less chance of short-circuiting adjacent bus bars, which could damage the battery cells or the BMS.

Note: At the time of writing, calibration can only be done via the iPhone app, or the JBTools USB Windows application. These instructions cover the iPhone app.

Open the app. Click on **Config**. Then **Voltage Cal**. A warning message will appear. Heed its advice and only continue if you know what you're doing.

A list of each cell's voltage will appear. Starting with Cell #1 (most negative), measure the cell voltage with the multimeter. Convert the voltage measurement into millivolts (multiply by 1000). Type this number into the app for Cell #1 (see image below). Click the **Write** button. Repeat for the remaining cells.

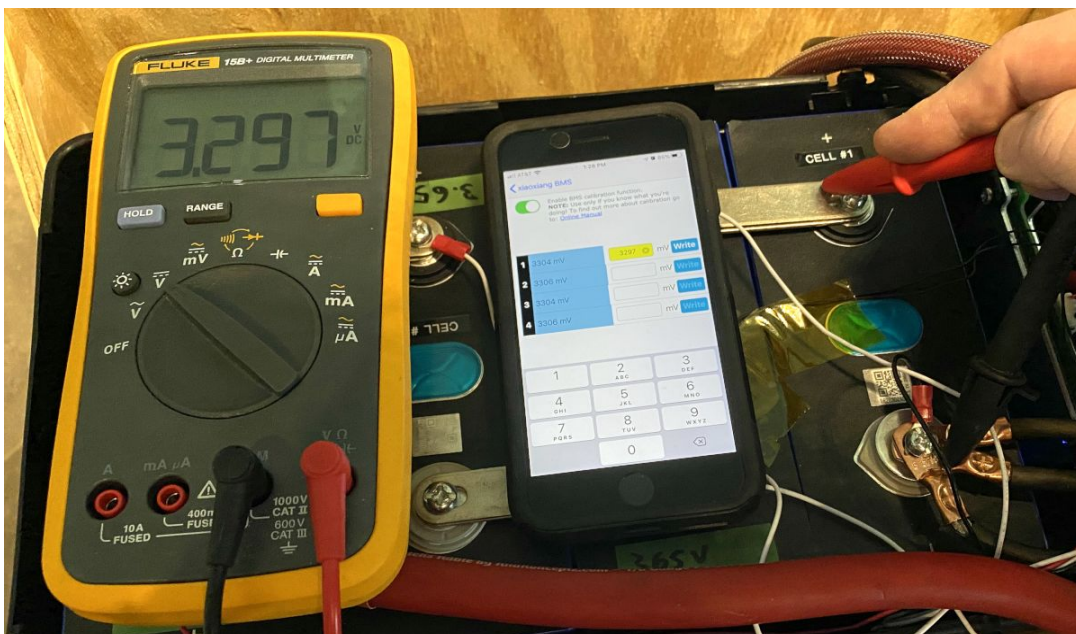

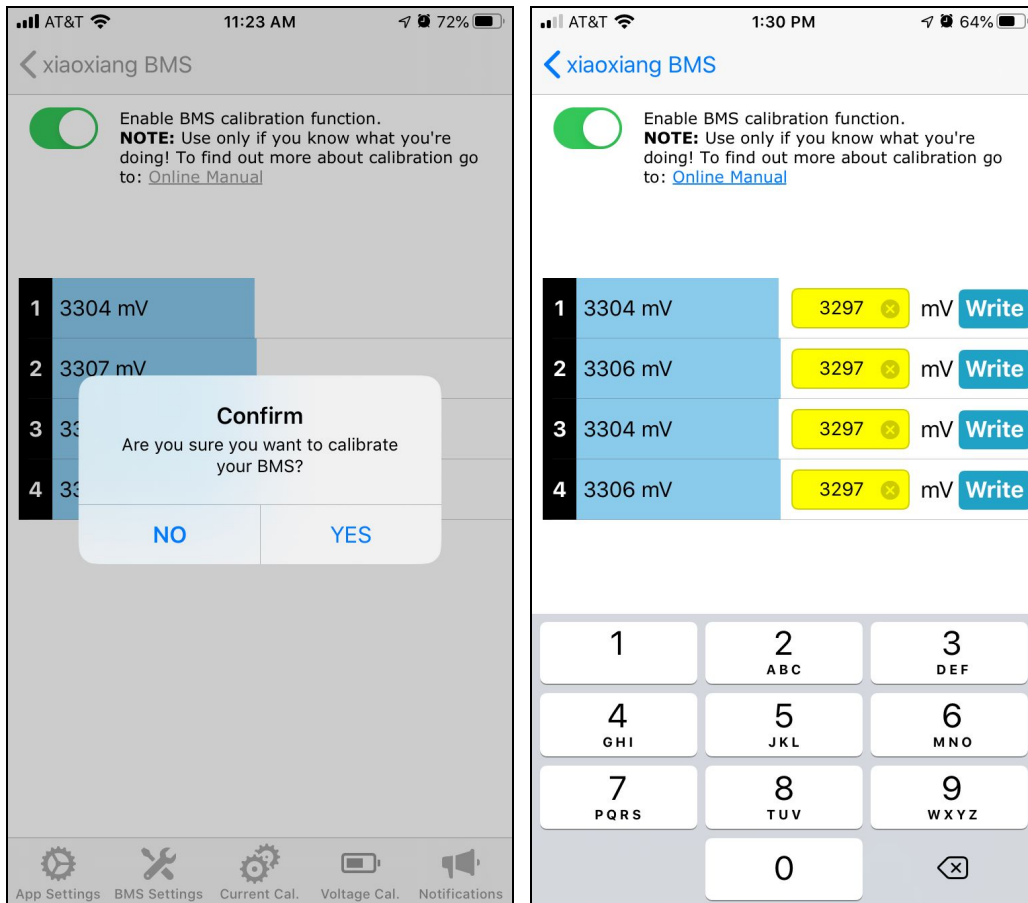

B.2 Current Calibration

You will need an accurate current meter to perform current calibration, and it must be able to measure the maximum current that the BMS is capable of withstanding. Most handheld meters will only measure up to 10 amps; these are not sufficient. We recommend a clamp meter capable of measuring DC current at greater than 100 amps, at an accuracy better than +/- 2.0%. If purchasing a new clamp meter, always make 100% sure that it will measure DC current. Cheaper models only measure AC current.

Note: At the time of writing, calibration can only be done via the iPhone app, or the JBTools USB Windows application. These instructions cover the iPhone app.

Open the app. Click on *Config*. Then *Current Cal.* A warning message will appear. Heed its advice and only continue if you know what you're doing.

B.2.1 Idle Current Calibration

Start by temporarily disconnecting all loads, and charge controllers. Double-check to make sure that nothing is connected to the battery. The current displayed should be zero milliamps, or very close to it. Do not proceed otherwise.

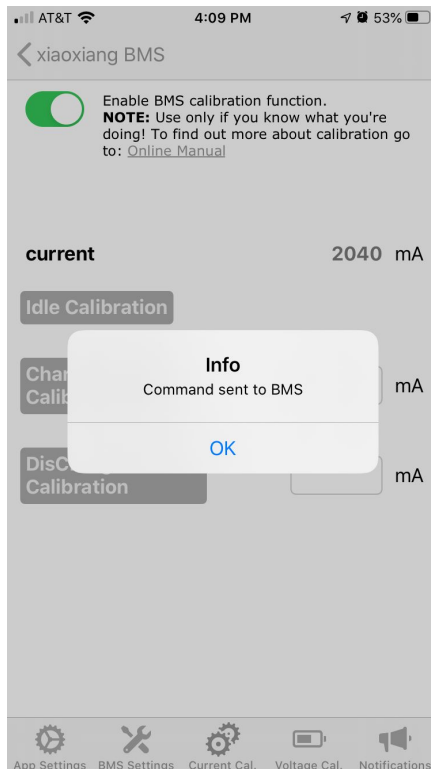

Click the “Idle Calibration” button. The app should display a message that the calibration command was sent to the BMS.

B.2.2 Charge Current Calibration

This test cannot be done when the batteries are fully charged. It is recommended to perform this step when the batteries are no more than 80% capacity.

Connect your MPPT controller or shore charger. If you are using MPPT / solar, ensure that it is a sunny day with all panels exposed to full sunlight. If you have multiple chargers, choose whichever is capable of charging the system the fastest. You may also use several chargers simultaneously; just do not exceed the maximum charge current of the BMS or the batteries. At this point, turn on the charger(s), and verify that they are running in the correct mode (e.g. bulk mode). Refer to your charger’s user manual if necessary.

Clamp the current meter around the positive battery cable. Turn the meter on and to the highest DC current measurement range. If your meter has multiple current ranges, always start on the highest range, and only move down to the lower range(s) if the measured current is lower than the next lower range. For example, if your meter has two ranges, 400A and 40A, then start on 400A, and only move down to 40 if the current measures less than 40. This will ensure that you do not damage your meter.

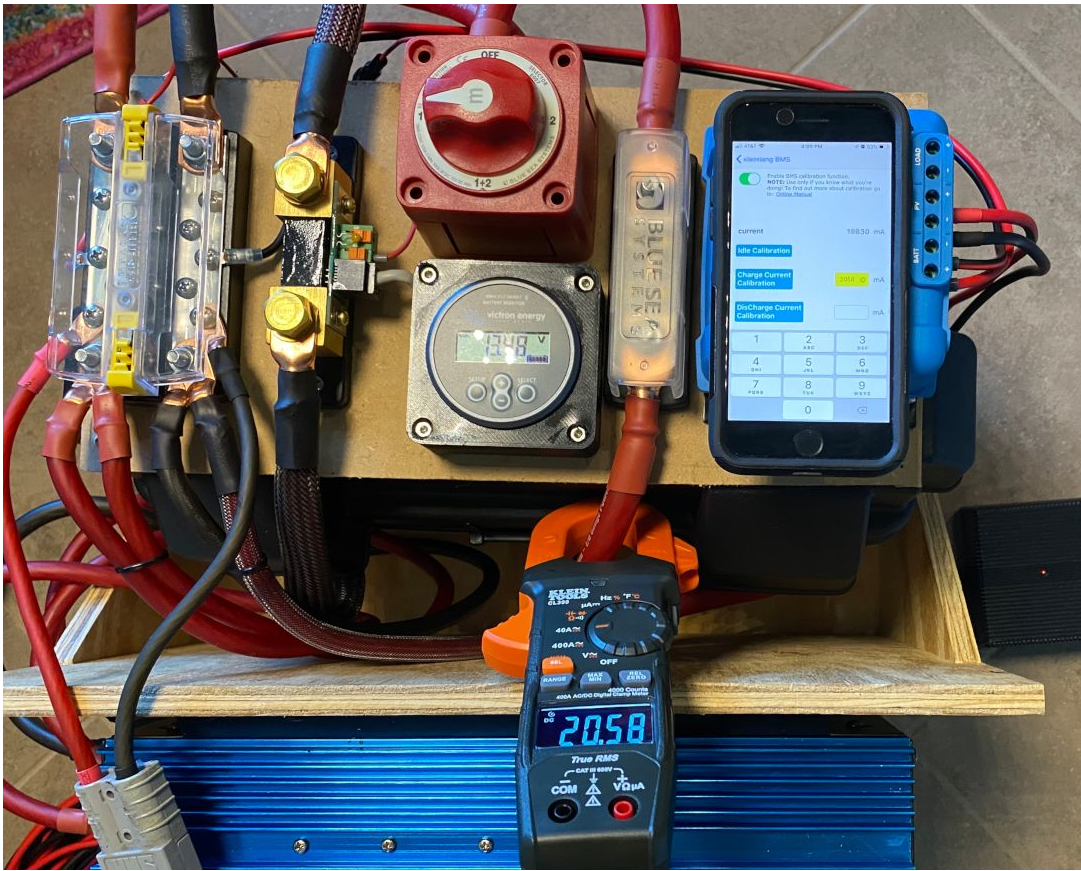

Note the value on the current meter. Convert this to milliamps (multiply the measured amperage by 1000). Enter this into the app's text box (see image below). Click the Charge Current Calibration button. This step will fail if the BMS is discharging or not charging. If successful, the app should display a message that the calibration command was sent to the BMS.

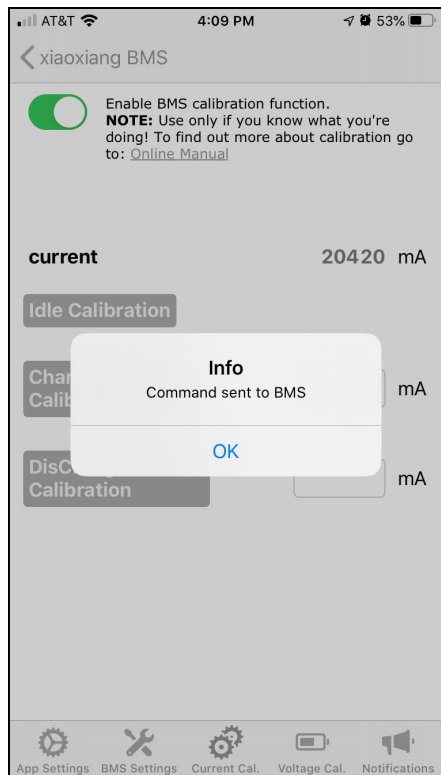
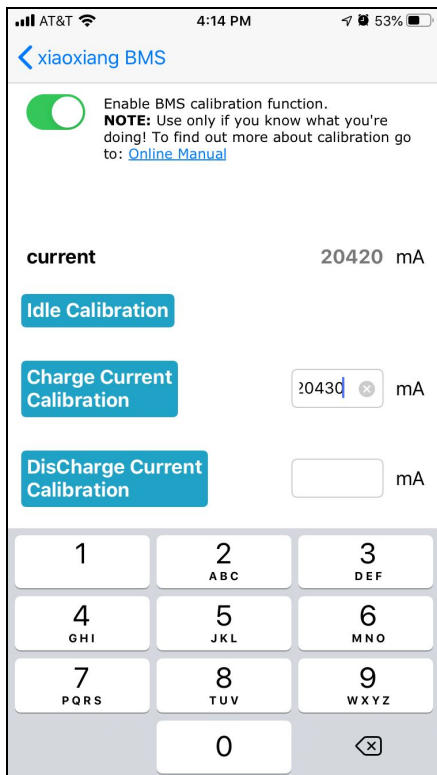

B.2.3 Discharge Current Calibration

Connect a large non-inductive load to the battery. An AC inverter and a heater or heat gun works great for this. For the 12V 4-cell BMS, a 1500 watt heat gun is perfect. Make sure that all chargers and MPPT controllers are unplugged or disabled. Get the load connected, but don't turn it on yet.

Next, get the phone app ready. Navigate to the same screen (Current Cal.), and put the cursor into the discharge current text box (see image below).

Turn on the clamp meter. Select DC current at the appropriate range (For the meter shown below, which has ranges for 40A or 400A, the 400A range was selected). Turn on the load for a few seconds, and ensure that the current is displayed on the meter, and on the iPhone app. Make sure that the current is in the right range (100-120 amps is ideal). Ensure that the BMS doesn't go into discharge current protection, and ensure that the inverter doesn't go into protection either (most will beep incessantly if the load was too high). Turn the load off. If all of this looks OK, proceed below.

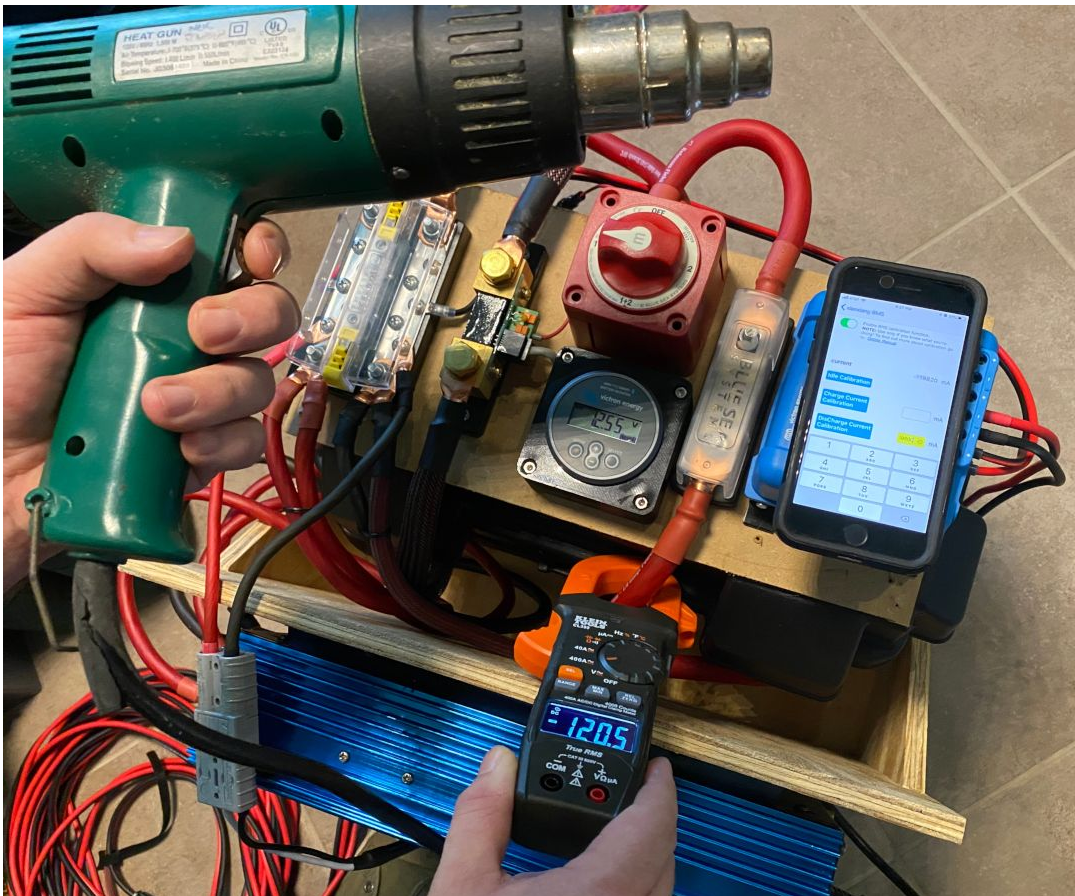

Now, on to the actual discharge current calibration. Make absolutely sure these steps are followed exactly.

1. Turn the load on
2. Read the current on the clamp meter.
3. Convert this number to milliamps (multiply the current in amps by 1000). For example, if it reads 120.5 amps, then the current in milliamps is 120500.

4. Type this number into the iPhone app. You do not need to enter a negative sign, even though the current is displayed as negative when discharging.
5. **Keep the load on, do not turn it off yet!**
6. Click the Discharge Current Calibration button.
7. Wait for a message that indicates whether the BMS successfully wrote the value to memory or not.
8. Finally, turn the load off.

If you happen to turn the load off before clicking the button, then it will be difficult to fix. Contact support if this happens.

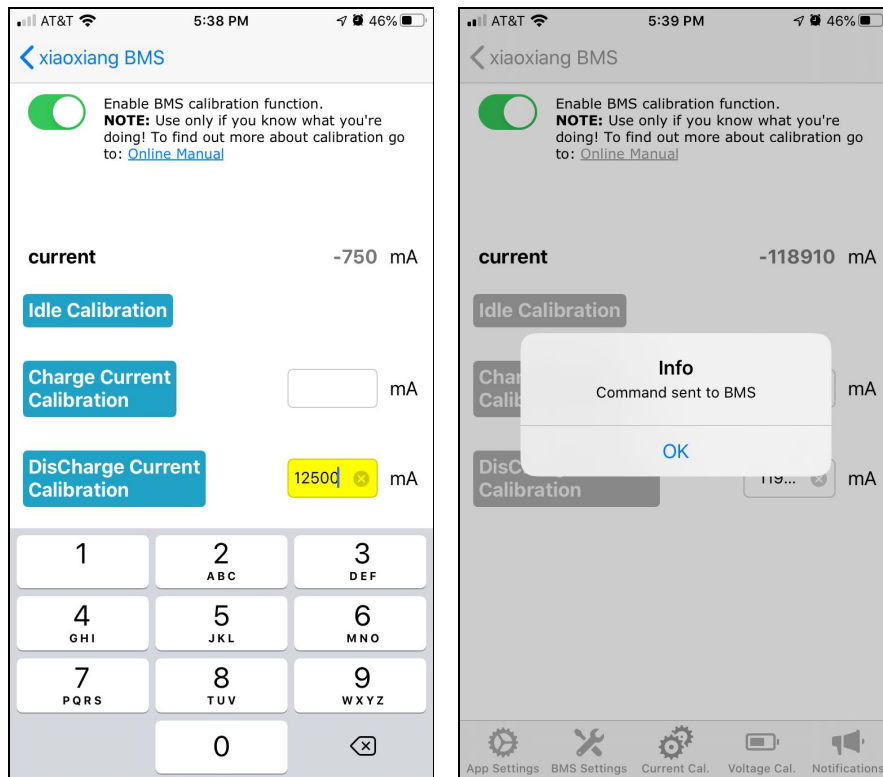

Appendix C: About Cell Balancing

In Section [Section 2.3](#), we asserted that each battery cell **must** be top-balanced separately, before assembling the battery pack.

Here, we will prove why.

Q: But Steve, doesn't the BMS have a built-in balancer?

A: Yes, the BMS has a built-in balancing function. *HOWEVER* no, it is not capable of doing an initial balance on new cells.

The balancer works by connecting a tiny bleed resistor (see Figure C.1 below) to the cells with the highest voltage, and the excess energy in those cells turns into waste heat. This is a slow process. The intention is that the BMS can maintain the balance on the cells as they slowly drift over their lifetime.

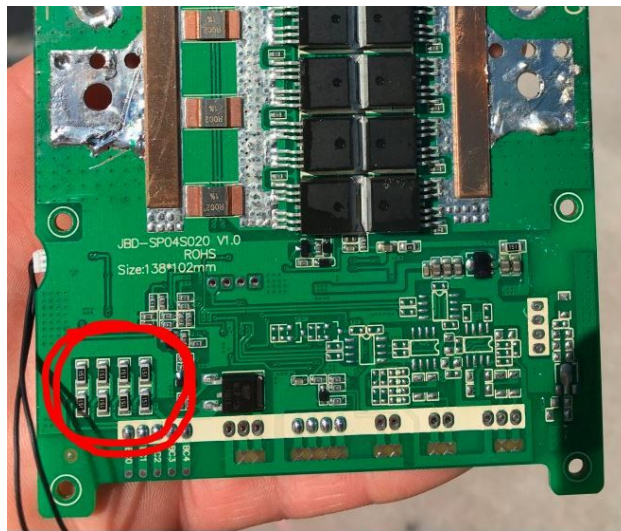

Figure C.1: Bleed Resistors within the 12V BMS

A batch of new cells needs to be top-balanced before they can be expected to charge properly as a battery pack.

Q: Why?

A: Because of the nature of the LiFePO₄ voltage curve. At the top end of a charge cycle, the cell voltage spikes quickly, and charging must be stopped to prevent damage to the cells. If one cell is at a higher state of charge, (in terms of amp-hours or coulombs), even by a small amount, it will spike while the other cells are still in the "bulk" phase of their charge cycle (See Figure C.1 below). On the linked graph, the red line is the highest cell, which triggers a "cell overvoltage" alarm before the pink/green cells get to a full charge. The BMS must then disconnect to protect the high cell, and the battery pack will be at a lower voltage than expected. You want all the cells to spike up at the same time, and the only way this can happen is for them to be well balanced.

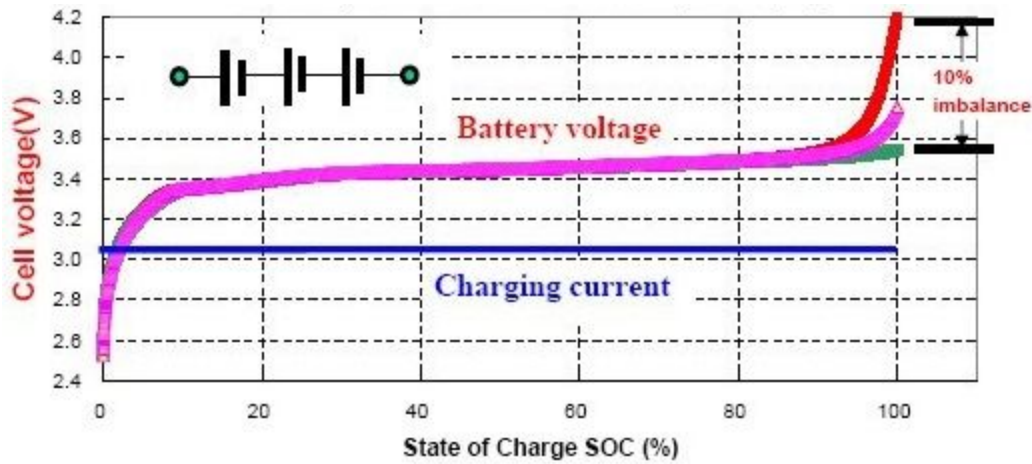

Figure C.1: LiFePO4 Cell Spikes During Charging

Q: OK, so how would one go about top-balancing their cells?

A: There are several ways to manually balance cells, depending on what equipment you have access to:

The best way in my opinion, is to use a regulated power supply to charge the cells to 3.65 volts each. The cells would be connected in parallel as a single cell and charged together (without the BMS), then re-assembled into the series-connected pack with the BMS. Will Prowse demonstrates in this video:

<https://youtu.be/x5ABvbbics8>

Cheapest way: Connect a load to the high cell in your pack to quickly bleed off the excess energy. I tried this method using a random car light bulb with some alligator clips on the leads. (see Figure C.3 below) You need to watch the cell voltages closely because it's easy to go too far.

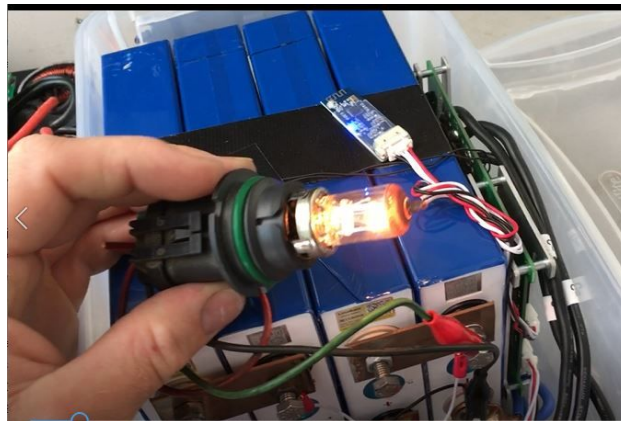

Figure C.3: Using a car light bulb to bleed off excess cell voltage

What does NOT work is the old recommendation of connecting your new cells in parallel and letting them passively equalize for hours or days. This does not work because of the flat charge curve. They are at almost the same voltage even if they are far apart in state-of-charge. Basically the cells don't know that they aren't balanced unless you can push them into the very top end of the charge cycle.

Q: What about cell matching?

A: Cells have a certain internal resistance. Grade-A cells are tested at the factory to confirm that their internal resistance is acceptable, usually <1 milliohm. If your battery pack is made of grade-B cells or cells of different

ages or if they have been damaged before, then they are not matched. Mismatched cells will quickly become unbalanced when the pack is cycled. This is one reason why you should pay for good grade-A cells.

I bought 4 of the very cheapest low grade garbage cells from Aliexpress (See Figure C.4 below), just for experimenting. I balanced them several times, but after even 1 cycle of charging and discharging, they are way out of balance. This is because they are not matched at all. Some cells have a high internal resistance, so they get hotter than the better cells, and this puts them at a lower state of charge. If you are trying to use crappy cells like this, you will only be able to charge them up to ~80% to avoid constant cell over-voltages. This might be good for a big cheap solar storage bank, but it can cause big problems for a pack that you cycle daily, or use with large loads.

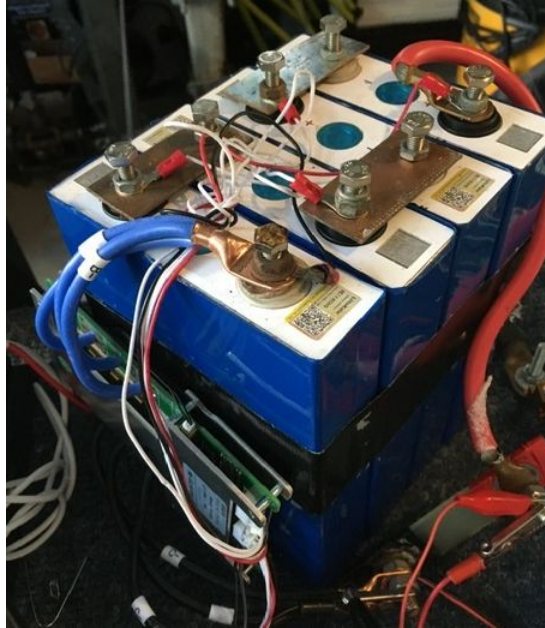

Figure C.4: Experimenting With Cheap Cells

Q: *I'm still not convinced.*

A: Here's a real-world scenario that happened. A vendor in China that won't be named shipped four 280Ah LiFePO4 cells to a customer in Florida. This vendor was nice enough to email a video of the battery voltages being measured before they were shipped. Here were the voltages, screen-captured :

- Cell 1: 3.3298V
- Cell 2: 3.2999V
- Cell 3: 3.3281V
- Cell 4: 3.3269V



Figure C.5: Measuring Cells Like This Doesn't Mean Much

From this info, we can work out that the cell delta is 29.9 millivolts. No need to top-balance these cells, right? They're almost identical, right? The customer figured as much, because he didn't top-balance them. He was in a hurry. Here was the output from the BMS iPhone app during the initial bring-up of the pack, after less than 1/2 hour of charging::

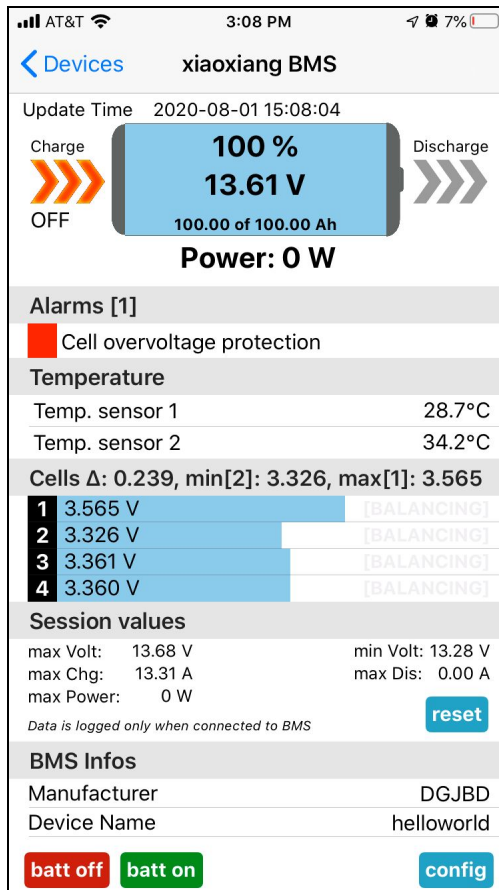

Figure C.6: The effects of a badly-balanced cell

Steve's advice to the customer, thinking that these might be crappy cells, was to top-balance the batteries. The customer did so, and reported that three of the cells took approximately 7.5Ah, but cell #2 charged for over a day, and when it was finished took a total of around 140 Ah. With that, we can work out a timeline of what happened:

1. The supplier from China shipped three of the batteries at 90% charge, and one battery at 50% charge. This should never happen. But it happened.
2. The supplier's reassuring video of the cell voltages didn't mean anything. Recall that LiFePO4 battery discharge curves are **extremely** flat. This means that the capacity can vary wildly, but the voltage won't change much. We can actually see in the measurements from the vendor that the delta was 30 millivolts. Consulting the discharge curve for the battery above, a 30 millivolt delta (which we saw in cell #2) can mean as much as a 40% state of charge difference.
3. During the battery pack bring-up, the cell overvoltage protection kicked in on cell #1, and cut off the charging current. This happened because the cells were not balanced.
4. Steve recommended a top-balance, which was done, taking over a day at a charge rate of 10 amps.

After the pack was reassembled, the cell delta was around two millivolts (much better). The battery successfully discharged down to its cutoff limit, and charged back up to 100% with no issue.

This, dear reader, is why you top balance. Don't trust voltages when working with LiFePO4 batteries. When it comes to vendors, the rule is: **Trust, but verify.** Verify by top-balancing.

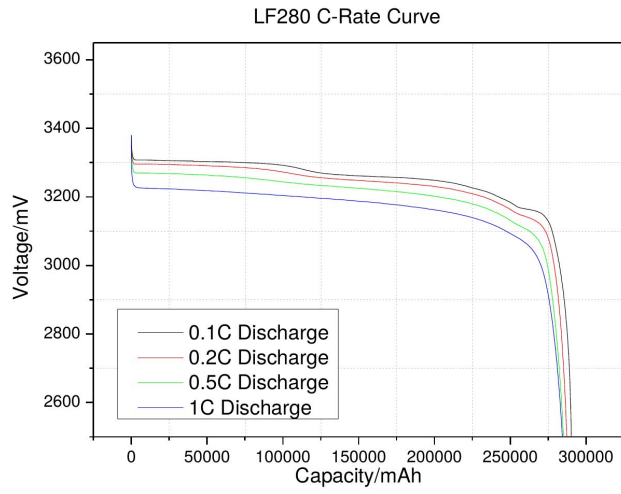

Figure C.7: LiFePO₄ battery discharge curves are extremely flat

Appendix D: BMS Specifications

	JBD-SP04S020	JBD-SP10S009
# of cells supported	4	8
Battery pack voltage (nominal)	12V	24V
Maximum charge current (continuous)	120A (configurable)	100A (configurable)
Maximum discharge current (continuous)	120A (configurable)	100A (configurable)
No-load current when operating	5.5 mA (BMS active, no Bluetooth) 15 mA (BMS active, Bluetooth) 0.8 mA (BMS inactive)	TBD
Pack over-voltage cutoff?	Yes (configurable)	Yes (configurable)
Pack under-voltage cutoff?	Yes (configurable)	Yes (configurable)
Individual cell over-voltage cutoff?	Yes (configurable)	Yes (configurable)
Individual cell under-voltage cutoff?	Yes (configurable)	Yes (configurable)
Current over-discharge cutoff?	Yes (configurable)	Yes (configurable)
Current over-charge cutoff?	Yes (configurable)	Yes (configurable)
High-temperature cutoff?	Yes (configurable)	Yes (configurable)
Low-temperature cutoff?	Yes (configurable)	Yes (configurable)
Bluetooth?	Optional	Optional
Communications port?	Yes (5V TTL serial, 9600 8n1, via JST XH 4-pin connector)	Yes (5V TTL serial, 9600 8n1, via JST XH 4-pin connector)
Wire length	6" (152mm) (12" or 24" optional)	6" (152mm) (12" or 24" optional)
Wire gauge	10 AWG (6mm ²) (8 AWG optional)	10 AWG (6mm ²) (8 AWG optional)
Dimensions (not including wires)	4" W x 5.4" H x 0.65" T (102mm W x 138mm H x 16.5mm T)	4" W x 5.9" H x 0.7" T (102mm W x 150.5mm H x 18mm T)
Weight	10 ounces (290 grams)	12 ounces (340 grams)

D.1. Pinouts

D.1.1 BMS Balance Connector (12V)

12V BMS connector:



Connector type: **JST XH**

Pin	Name	Function	Wire color
1	BC4	Balance tap. Cell #4 positive	Red
2	BC3	Balance tap. Cell #3 positive & Cell #4 negative	White
3	BC2	Balance tap. Cell #2 positive & Cell #3 negative	White
4	BC1	Balance tap. Cell #1 positive & Cell #2 negative	White
5	BC0	Balance tap. Cell #1 negative	Black

Part Numbers:

- Female housing: [JST XHP-5](#)
- Pins for female housing: [JST SXH-001T-P0.6](#)
- Male connector, through-hole, vertical: JST [B5B-XH-A](#)
- Male connector, through-hole, right-angle: JST [S5B-XH-A-1](#)

24V BMS connector:



Connector type: **JST XH**

Pin	Name	Function	Wire color
1	BC8	Balance tap. Cell #8 positive	Red
2	N/C	No connection	N/A
3	BC7	Balance tap. Cell #7 positive & Cell #8 negative	White
4	BC6	Balance tap. Cell #6 positive & Cell #7 negative	White
5	BC5	Balance tap. Cell #5 positive & Cell #6 negative	White
6	BC4	Balance tap. Cell #4 positive & Cell #5 negative	White
7	N/C	No connection	N/A
8	BC3	Balance tap. Cell #3 positive & Cell #4 negative	White
9	BC2	Balance tap. Cell #2 positive & Cell #3 negative	White
10	BC1	Balance tap. Cell #1 positive & Cell #2 negative	White
11	BC0	Balance tap. Cell #1 negative	Black

Part Numbers:

- Female housing: JST [XHP-11](#)
- Pins for female housing: [JST SXH-001T-P0.6](#)
- Male connector, through-hole, vertical: JST [B11B-XH-A](#)
- Male connector, through-hole, right-angle: [JST S11B-XH-A-1](#)

D.1.2 BMS Serial Interface Connector

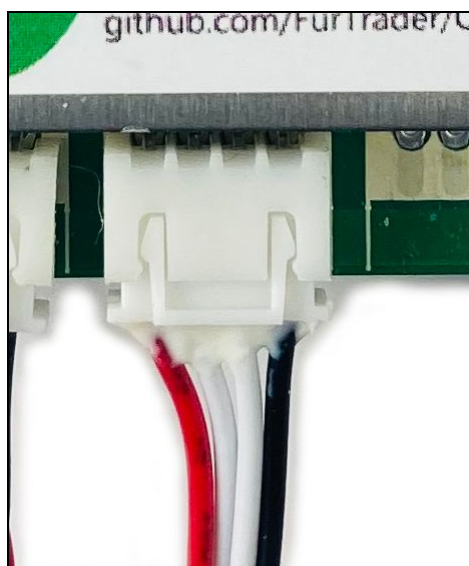

Connector type: **JST XH**

Pin	Function	Wire color
-----	----------	------------

1	VDD	Red
2	TX (BMS to client)	White
3	RX (client to BMS)	White
4	Ground	Black

Note: The Bluetooth module's serial interface connector is wired backwards from above. Pins 1 and 4 are swapped, and pins 2 and 3 are swapped.

Part Numbers:

- Female housing: [JST XHP-4](#)
- Pins for female housing: [JST SXH-001T-P0.6](#)
- Male connector, through-hole, vertical: JST [B4B-XH-A](#)
- Male connector, through-hole, right-angle: JST [S4B-XH-A-1](#)

D.1.3 BMS Switch Connector

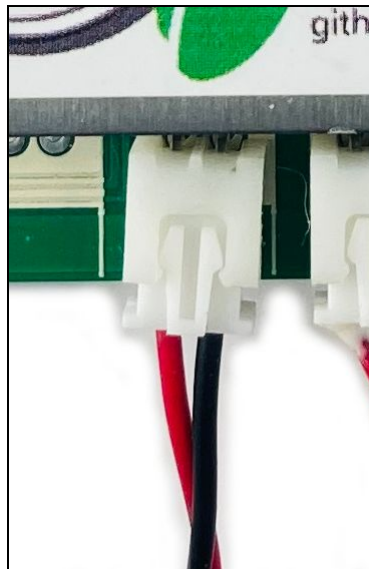

Connector type: **JST XH**

Pin	Function	Wire color
1	Switch contact #1	Red
2	Switch contact #2	Black

Note: Connect a normally-closed switch to the two wires.

Part Numbers:

- Female housing: [JST XHP-2](#)
- Pins for female housing: [JST SXH-001T-P0.6](#)
- Male connector, through-hole, vertical: JST [B2B-XH-A](#)
- Male connector, through-hole, right-angle: JST [S2B-XH-A-1](#)

D.1.4 BMS Temp Sensor Connector

Connector type: **Don't know**. Use the included temperature sensors. Try not to lose them.

The temperature sensors themselves are 10K Ω NTC (negative temperature coefficient) bead-type [thermistors](#). Thermistors are not polarized, but the connector can only be plugged in one way.

Appendix E: BMS Application Usage

E.1. XiaoxiangBMS (iPhone)



1. Download the iPhone application from the app store. Link: <https://apps.apple.com/us/app/xiaoxiang-bms/id1375405426>
2. Open the app. Ensure that the phone's bluetooth has not been disabled (Settings -> Bluetooth -> enable the top Bluetooth radio button)
3. Ensure that your battery pack is fully assembled and operational.
4. The iPhone app communicates via Bluetooth. So ensure that the bluetooth module is present and plugged in.
5. Open the app. Your BMS should be immediately enumerated in the list of devices found. Click on the device.
6. The basic info for your BMS should now be displayed.

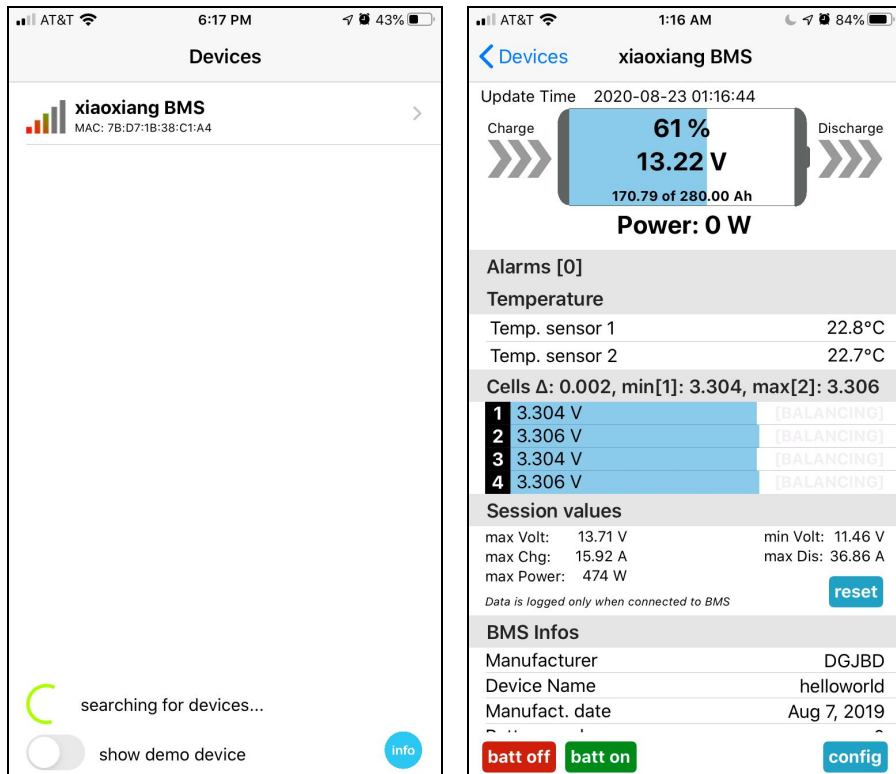

To edit the BMS settings, or to perform BMS calibration, you must purchase the pro version, which at the time of writing, costs \$5.99. After purchasing the pro version, the Config button can be clicked to bring up the config page.

There are five configuration pages:

1. **App Settings:** In this screen, you can give each BMS in your system a descriptive name. You can also change the battery temperature display units to Celsius or Fahrenheit.
2. **BMS Settings:** In this screen, you can read and write the BMS settings. To do this, first click the BMS read button. This will populate the page with settings from the BMS. Then, after updating the settings, click BMS write. This will update the BMS. See [Appendix A](#) for recommended settings. Settings may also be saved and loaded to a file.
3. **Current Calibration:** In this screen, the charge and discharge current readings can be calibrated. See [Section 4.2](#) for calibration instructions.
4. **Voltage Calibration:** In this screen, the idle, charge, and discharge voltage readings can be calibrated. See [Section 4.1](#) for calibration instructions.
5. **Notifications:** In this screen, optional notifications may be added. This will send an alert to your phone when something bad happens. However, it will only alert you if the app is running and the BMS is within range of the phone. Which makes it impractical in the real-world.

E.2. Xiaoxiang (Android)

This application was provided by the manufacturer of the BMS.

1. Download the application from here: [Android_app_xiaoxiangBMS_3.1.1015.apk](#)
2. Install the application. You may have to configure the permission settings on your phone to allow this application to be run. After it is installed, run the app.
3. Ensure that your battery pack is fully assembled and operational.

- The Android app communicates via Bluetooth. So ensure that the bluetooth module is present and plugged in. Note that you must grant the application access to the device's location. Android requires location access to grant the application access to the Bluetooth device. For more information on why this is, please see the FAQ question "My Android device says "Pairing Rejected". What does that mean?" in [Section 5](#).
- Your BMS should be immediately enumerated in the list of devices found. Click on the device. Wait momentarily while the app connects to the BMS.
- The application will display a dialog window that allows the user to set the nominal capacity and the cycle capacity. In the image below, the user customized the capacity to 280 Ah.
- The application may display another dialog window, asking, "use GPS to test speed? Yes / No". This question is not applicable to OverkillSolar BMS (some versions of the BMS from the manufacturer include GPS, as they are intended to be installed in electric scooters). Simply click No.
- The basic info for your BMS should now be displayed.

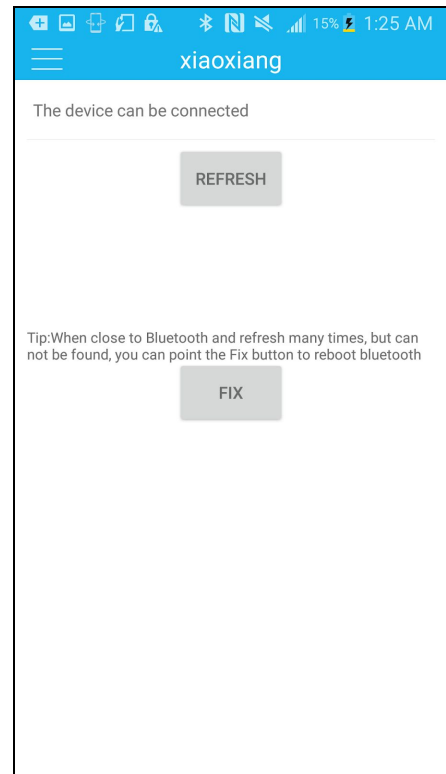
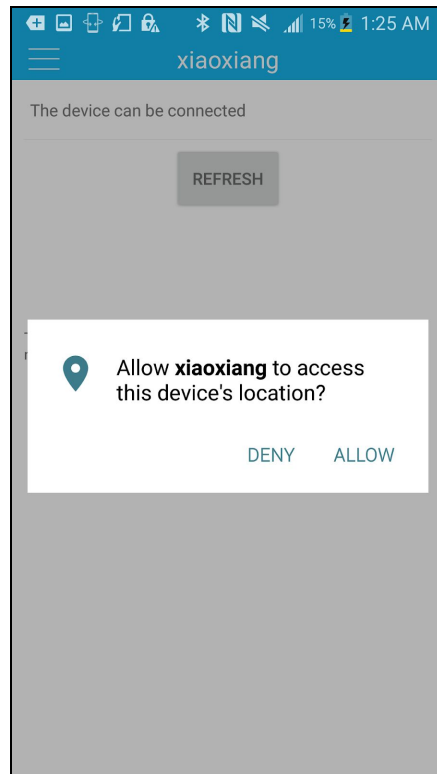
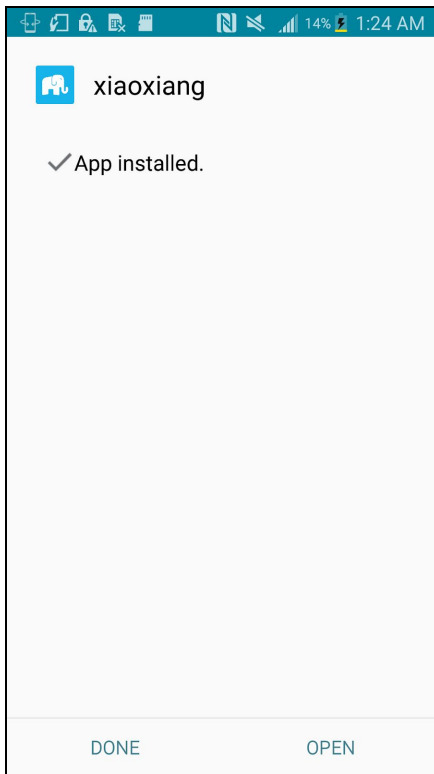

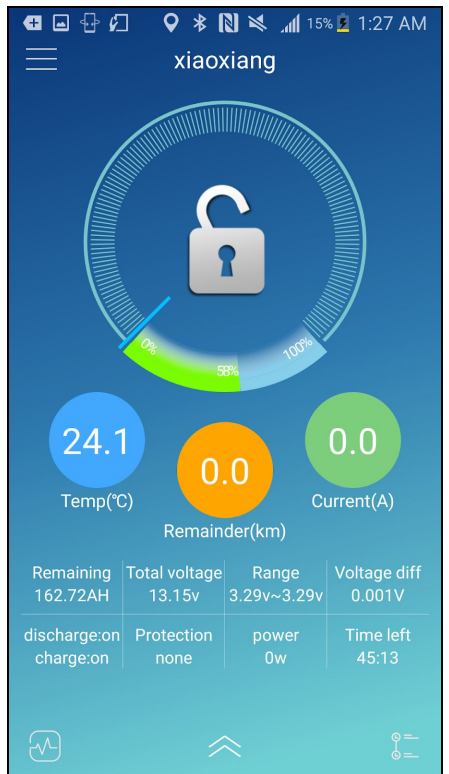
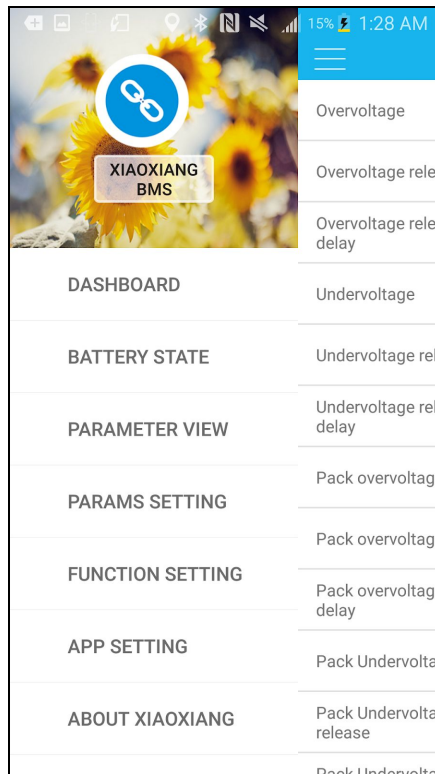
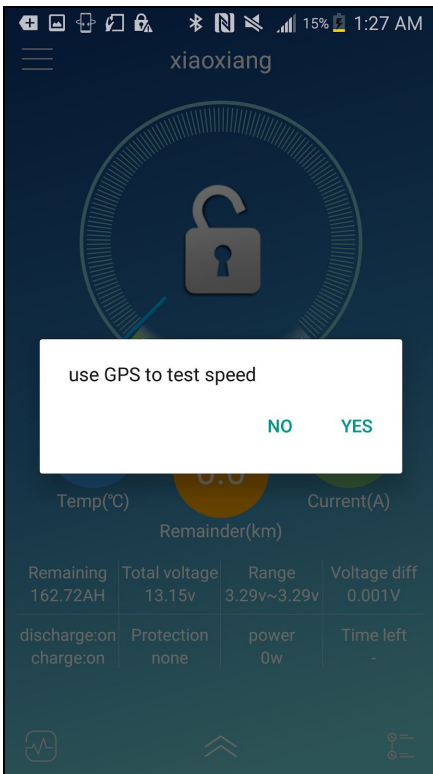
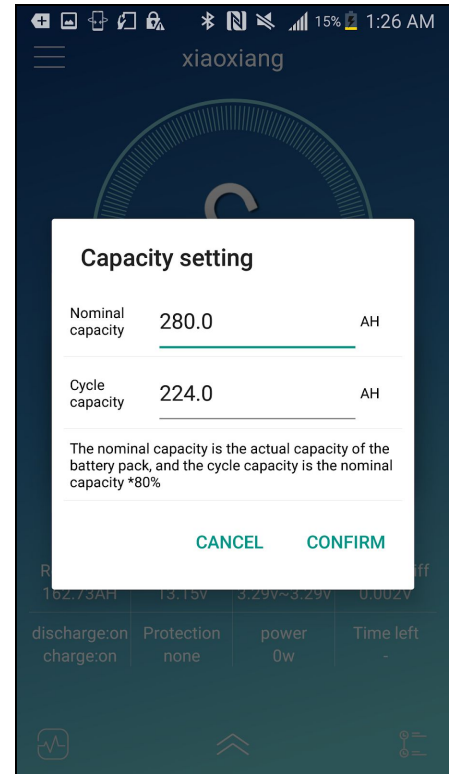
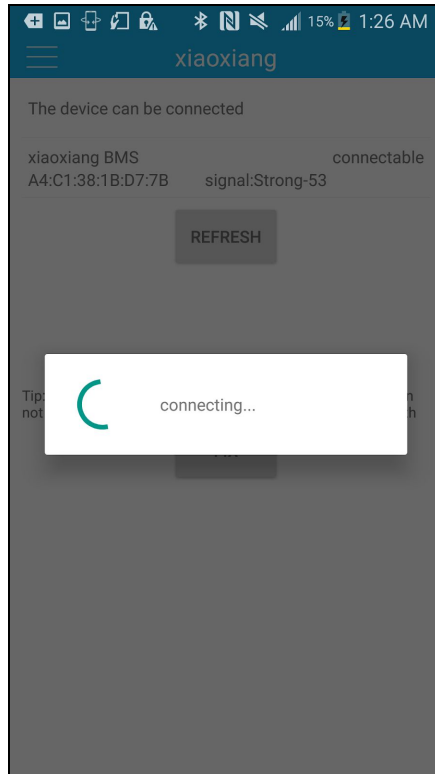
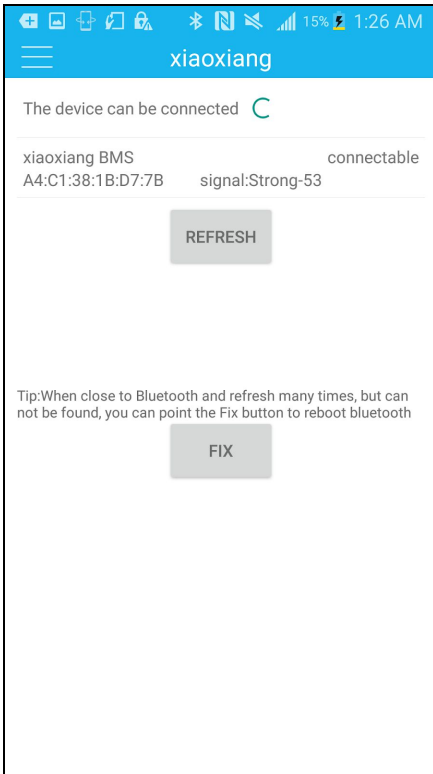

By clicking on the top-right nav icon, you can navigate to the app's sub-pages:

1. **Dashboard:** This navigates back to the main menu
2. **Battery State:** In this screen, you can view individual cell voltages
3. **Parameter View:** In this screen, you can read the BMS settings. See [Appendix A](#) for recommended settings.

4. **Params Setting:** In this screen, you can read and write the BMS settings. See [Appendix A](#) for recommended settings.
5. **Function Setting:** In this screen, the general BMS settings, can be set (external switch on/off, load check on/off, balance enable on/off, charge balance on/off, and NTC temp sensors on/off).
6. **App Setting:** asdf
7. **About XiaoXiang:** In this screen, you can view information about the author of this app.

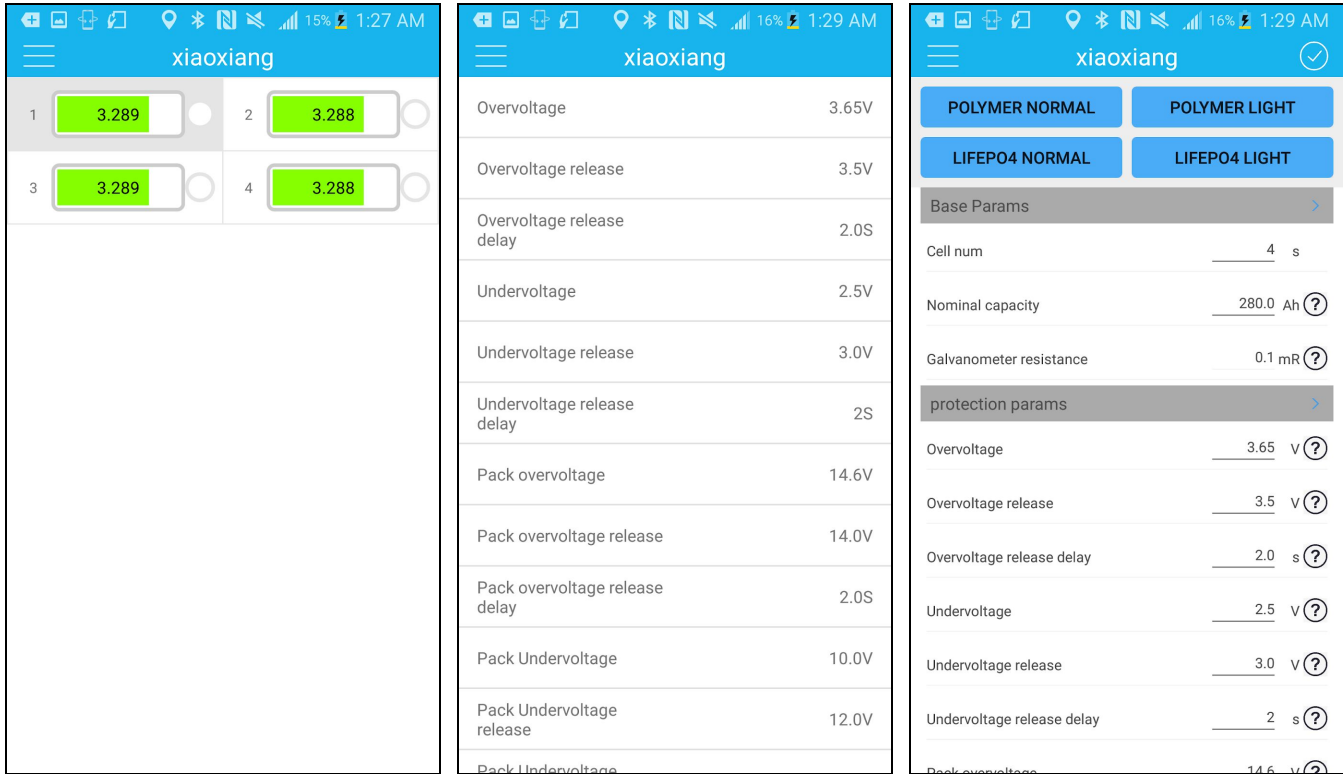

E.3. JBTools (PC)

This application was provided by the manufacturer of the BMS.

1. Download the application from here: [JBTools_V1.B-20180820.zip](#)
2. Install the drivers, if necessary (see [Section 2.4.7.1](#))
3. Plug in the USB adapter (see [Section 2.4.7.1](#)). Use Device manager to take note of what the COM port is. If you unplug the USB interface, the port should disappear and re-appear.
4. Open the application. When it opens, most of the text on the screen will be unreadable. This is because it was written in Mandarin Chinese. On the top-right part of the interface, click the button labeled “English.”
5. The interface should switch over to English (see image below).
6. Next, click the CommPort button.
7. Select the COM port that was previously identified in step 3. Press the OK button.
8. Press the Start button. The application should connect to the BMS via the USB interface, and the screen should populate with real-time BMS data.

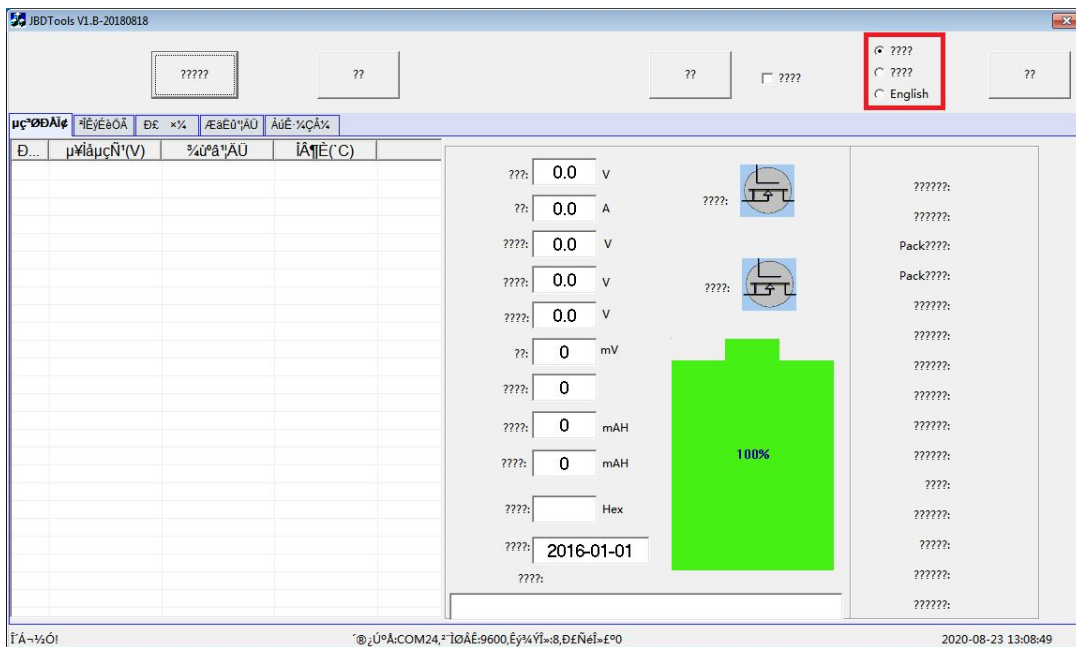
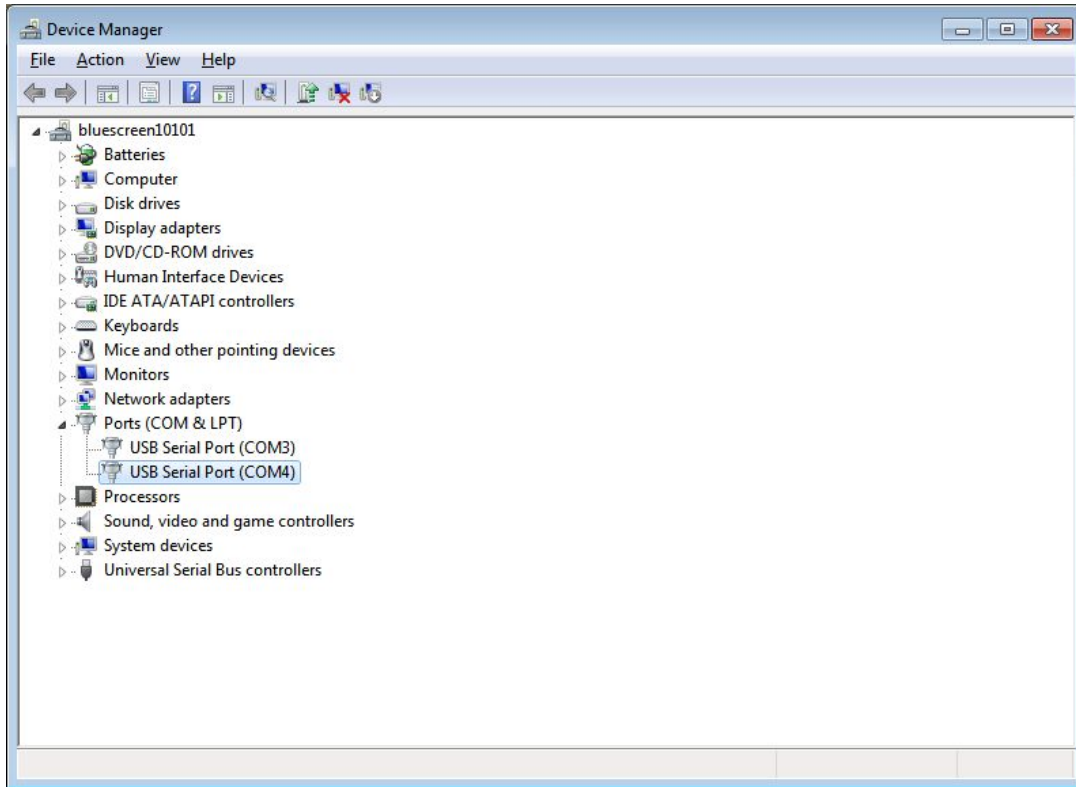

JBDTools V1.B-20180818



CommPort Start Upgrade Save Data Help

English

PackInfo Parameter Calibration Other functions

NO.	Voltage)	Balance	Temp(C)

Voltage: 0.0 V
Current: 0.0 A
Avg Cell: 0.0 V
Max Cell: 0.0 V
Min Cell: 0.0 V
Diff Voltage: 0 mV
CycleCount: 0
FCC: 0 mAh
RemainCap: 0 mAh
Version: Hex
Date: 2016-01-01
HardwareInfo:

CHG_FET: 
DSG_FET: 

100%

CELL OVP:
CELL UVP:
PACK OVP:
PACK UVP:
CHG OTP:
CHG UTP:
DSG OTP:
DSG UVP:
CHG OCP:
DSG OCP:
SHORT Circuit:
AFE ERROR:
SOFT LOCK:
CHGOVERTIME:
DSGOVERTIME:

Not connected! ComPort:COM24,Baudrate:9600,data length:8 2020-08-23 13:10:07

COM Settings(???)

Com Port(???): COM3 Refresh(??)

Baud Rate(???): 9600

Parity Bit(???): NONE

Data Bit(?????): 8

Stop Bit(?????): 1 RTC

?(OK) ??(CANCEL)

JBDTools V1.B-20180818



CommPort Stop Upgrade Save Data Help

English

PackInfo Parameter Calibration Other functions

NO.	Voltage)	Balance	Temp(C)
1	3.289		23.7
2	3.288		24.0
3	3.288		
4	3.288		

Voltage: 13.15 V
Current: 0.00 A
Avg Cell: 3.287 V
Max Cell: 3.289 V
Min Cell: 3.288 V
Diff Voltage: 1 mV
CycleCount: 0
FCC: 280000 mAh
RemainCap: 162730 mAh
Version: 15 Hex
Date: 2019-08-07
HardwareInfo: OverkillSolar

CHG_FET: 
DSG_FET: 

58%

CELL OVP:
CELL UVP:
PACK OVP:
PACK UVP:
CHG OTP:
CHG UTP:
DSG OTP:
DSG UVP:
CHG OCP:
DSG OCP:
SHORT Circuit:
AFE ERROR:
SOFT LOCK:
CHGOVERTIME:
DSGOVERTIME:

Read device successful... COM4, Baudrate:9600, Data length:8 2020-08-23 19:13:30

Appendix F: Wire and Lug Sizing

F.1 Wire Sizing Chart

We've provided the table below for convenience; it only lists common sizes and lengths in the context of wiring a battery pack. For a more complete guide, we recommend [Blue Sea System's page on choosing the correct wire size for a DC circuit](#).

For lengths of wire less than six feet (1.8 meters):

Desired current (amps)	Freedom Units	Closest metric size
5	16 AWG	1.5 mm ²
10	16 AWG	1.5 mm ²
15	14 AWG	2.5 mm ²
20	14 AWG	2.5 mm ²
25	12 AWG	4 mm ²
30	10 AWG	6 mm ²
50	6 AWG	16 mm ²
60	6 AWG	16 mm ²
80	4 AWG	25 mm ²
90	4 AWG	25 mm ²
100	4 AWG	25 mm ²
120	2 AWG	35 mm ²
150	1 AWG	50 mm ²
200	2/0 AWG	70 mm ²

F.2 Battery Bus Bar Sizing Chart

If your batteries did not come with bus bars, they may be fashioned from 3/4" wide copper bar material (110 alloy is 99.9% pure is recommended). Use the chart below to determine the correct thickness.

Note that these are general guidelines and may not be appropriate in all circumstances.

Desired current (amps)	Bar Size	McMaster Carr P/N
< 150	3/4" x 1/8"	2557T51
150 - 200	3/4" x 3/16"	2557T57

Cut the bar to the proper length, and drill slightly-oversized holes at the correct distance for your batteries. Optionally place heat-shrink tubing over the bare middle section, but ensure that it will not interfere with the electrical connection.

Appendix G: Glossary

AC: Alternating current. In the context of this document, this means wall power (or shore power, in the marine / RV parlance).

Balancing: The process of equalizing the voltages between series cells within a battery pack. This process can be passive (as is the case with our BMS), or active.

BMS: Battery management system.

Bus bar: Short, thick pieces of metal that connect individual cells together within a battery pack. Ideally made out of copper. Bus bars should be sized to the maximum expected current in the circuit, and should always be fully tightened, and checked periodically.

CC/CV: Constant-current, constant-voltage. This is a topology of power supply with the ability to regulate both current and voltage (though only one of these modes would be activated at a time). The supply will have controls for both, usually knobs, that define the maximum voltage and current. When on, the power supply will be in one of two modes: constant-current, or constant-voltage. Usually the mode will be indicated by LEDs. When in constant-voltage mode, the voltage will be regulated, and the current will vary depending on the load's needs. When in constant-current mode, the current will be regulated, and the voltage may vary depending on the load's needs. These power supplies are typically advertised as lab power supplies, and are typically used during the electronics prototyping process. They're great to have around, and have many uses. Every DIYer should consider having at least one.

Cutoff: A feature of the BMS, which will disconnect the battery from the charger and/or load when an error condition occurs.

Charge: When electric current is flowing into the batteries.

DC: Direct current. Batteries operate on direct current.

Discharge: When electric current is flowing out of the batteries, into the load.

Load: The portion of a circuit which consumes electric power. In this context of this document, a load is typically the items that are being powered by the battery and/or solar panels (e.g. lights, cooking equipment, computers, and phones).

Parallel: In the context of batteries, a parallel circuit is when multiple battery cells are connected with their positive terminals connected together, and their negative terminals connected together. This increases the current capacity of the battery, but not the voltage.

Self discharge: A battery's natural tendency to lose charge over time, even when no load is applied. It is caused by chemical reactions within the positive electrode, negative electrode, and/or the electrolyte.

All rechargeable batteries exhibit this behavior, although certain chemistries are less susceptible to it. Higher temperatures can accelerate self-discharge.

Series: In the context of batteries, a series circuit is when multiple battery cells are connected in a chain, so each cell's positive terminal is connected to the next cell's negative terminal. This increases the voltage, but not the current capacity.

Thermal runaway: A dangerous feedback cycle that occurs when batteries turn excess energy into heat, which in turn releases oxygen, which in turn makes more heat. This can result in venting, bulging, fire, and explosions, depending on the battery chemistry.

Appendix H: Further Reading

H.1 Mobile Solar Power Made Easy! By Will Prowse



This is a great book for beginners and intermediate DIYers. Lots of practical, real-world examples. Available from [Amazon](https://www.amazon.com) and mobile-solarpower.com