

Pb Free Plating Product

F30U60ST



30Amperes,600Volts Single Insulated Package Ultra Fast Recovery Epitaxial Diode

APPLICATION

- Freewheeling, Snubber, Clamp
- Inversion Welder
- PFC
- Plating Power Supply
- Ultrasonic Cleaner and Welder
- Converter & Chopper
- UPS

PRODUCT FEATURE

- Ultrafast Recovery Time
- Soft Recovery Characteristics
- Low Recovery Loss
- Low Forward Voltage
- High Surge Current Capability
- Low Leakage Current

ITO-220AC/TO-220F-2L

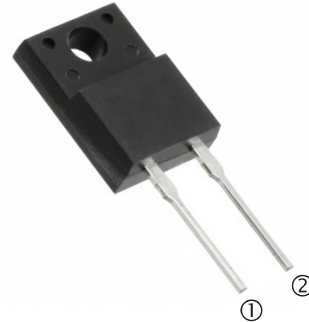

Internal Configuration

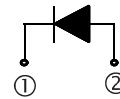

GENERAL DESCRIPTION

F30U60ST using the latest FRED FAB process(or planar passivation pellet) with ultrafast and soft recovery characteristics.

Absolute Maximum Ratings $T_C=25^\circ\text{C}$ unless otherwise noted

Symbol	Parameter	Value	Units
V_{RRM}	Peak Repetitive Reverse Voltage	600	V
$I_{F(AV)}$	Average Rectified Forward Current @ $T_C = 100^\circ\text{C}$	30	A
I_{FSM}	Non-repetitive Peak Surge Current 60Hz Single Half-Sine Wave	180	A
T_J, T_{STG}	Operating Junction and Storage Temperature	- 65 to +150	$^\circ\text{C}$

Thermal Characteristics

Symbol	Parameter	Value	Units
$R_{\theta JC}$	Maximum Thermal Resistance, Junction to Case	0.8	$^\circ\text{C/W}$

Electrical Characteristics $T_C=25^\circ\text{C}$ unless otherwise noted

Symbol	Parameter	Min.	Typ.	Max.	Units
V_{FM}^*	Maximum Instantaneous Forward Voltage $I_F = 30\text{A}$ $T_C = 25^\circ\text{C}$ $I_F = 30\text{A}$ $T_C = 100^\circ\text{C}$			2.3 2.1	V
I_{RM}^*	Maximum Instantaneous Reverse Current @ rated V_R $T_C = 25^\circ\text{C}$ $T_C = 100^\circ\text{C}$			15 150	μA
t_{rr} I_{rr} Q_{rr}	Maximum Reverse Recovery Time Maximum Reverse Recovery Current Maximum Reverse Recovery Charge ($I_F = 30\text{A}$, $di/dt = 200\text{A}/\mu\text{s}$)			90 8 360	ns A nC
W_{AVL}	Avalanche Energy	1.0			mJ

* Pulse Test: Pulse Width=300 μs , Duty Cycle=2%

Typical Characteristics

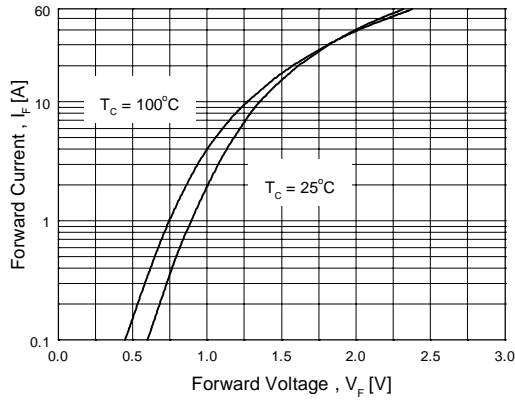

Figure 1. Typical Forward Voltage Drop vs. Forward Current

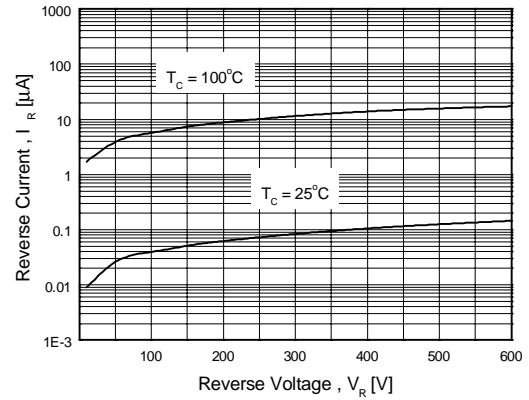

Figure 2. Typical Reverse Current vs. Reverse Voltage

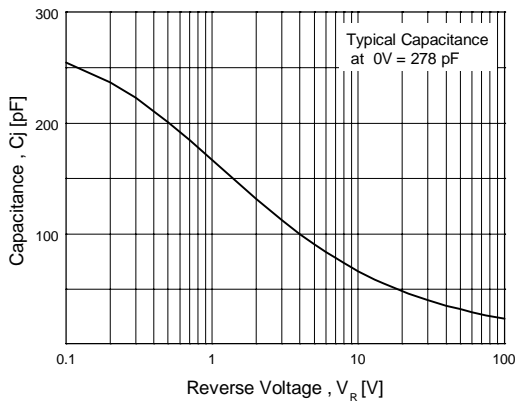

Figure 3. Typical Junction Capacitance

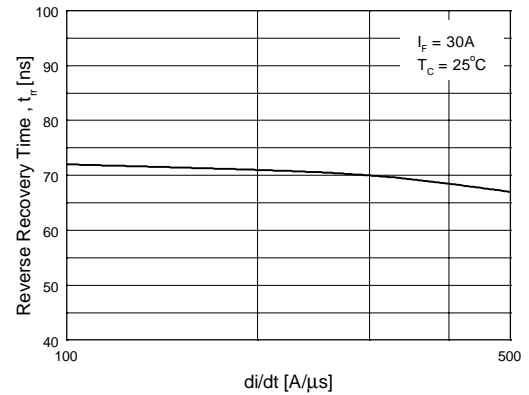

Figure 4. Typical Reverse Recovery Time vs. di/dt

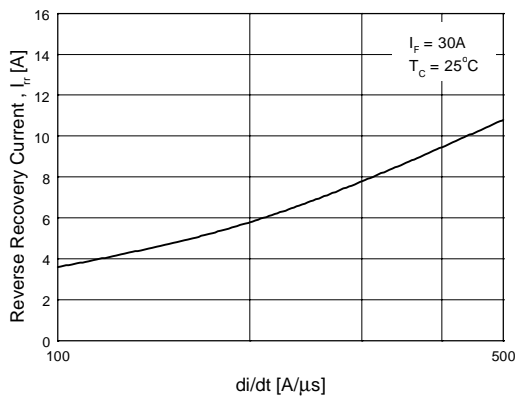

Figure 5. Typical Reverse Recovery Current vs. di/dt

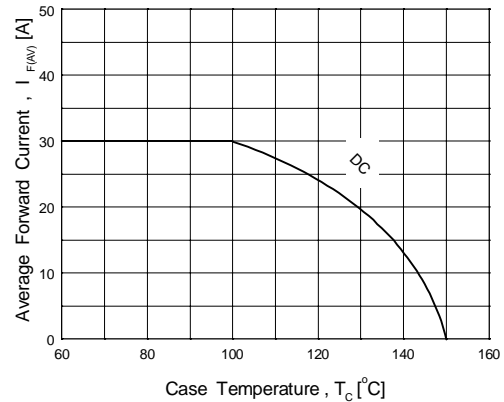
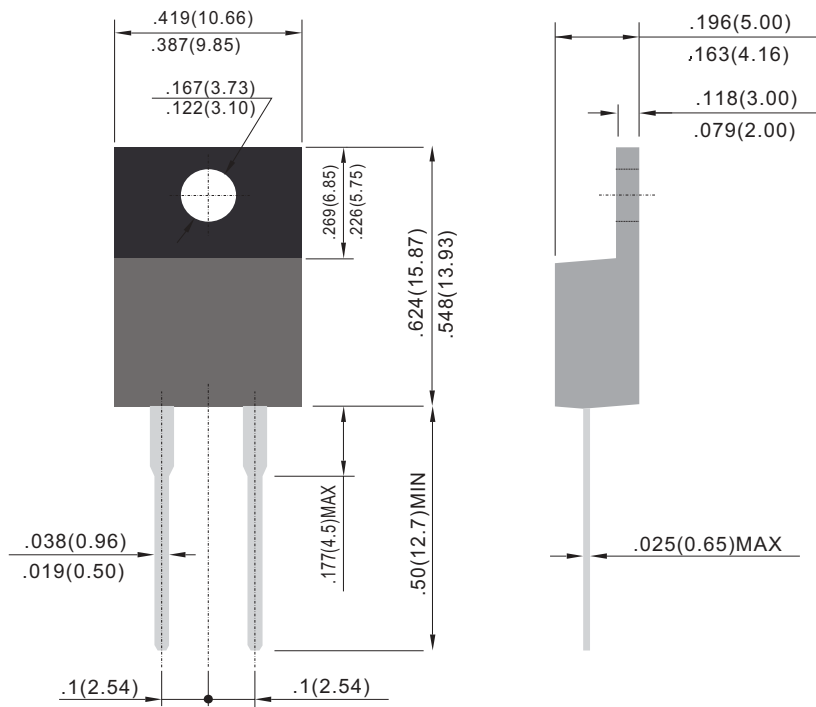

Figure 6. Forward Current Derating Curve

ITO-220AC/TO-220F-2L Package Outline:



Unit : inch (mm)