

Upgrade Guide

Removing the compartment cover

NOTE: The appearance of your Notebook PC's bottom view may vary per model.

- Remove the screw(s) from the Notebook PC's compartment cover.
- Loosen the Pop-open Screw without removing the screw from the cover.
- Pull out the compartment cover and remove it completely from your Notebook PC.

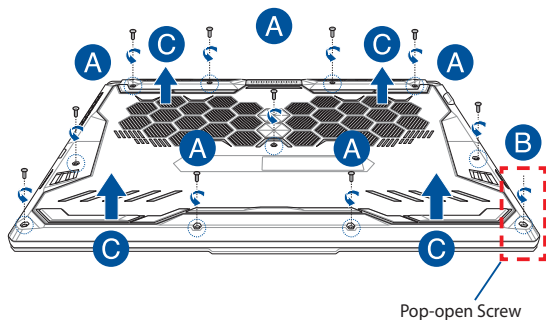

To reattach the compartment cover:

- A. Align and reattach the cover of the compartment.
- B. Secure the cover using the screw(s) you removed earlier.
- C. Tighten the Pop-open Screw.

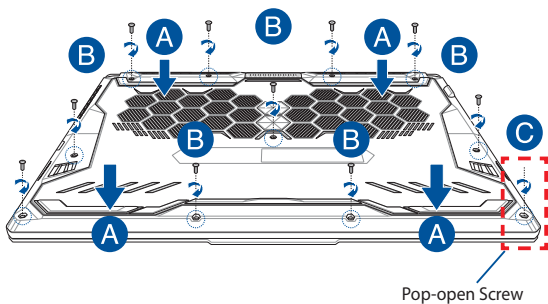

Cover screw map

15" model

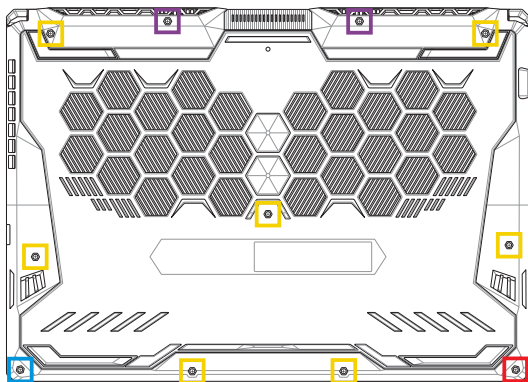

- M2.5 X 14 (2PCS)
- M2.5 X 11 (7PCS)
- M2.5 X 5.5 (1PC)
- M2.5 X 6 (1PC Pop-open Screw)

17" model

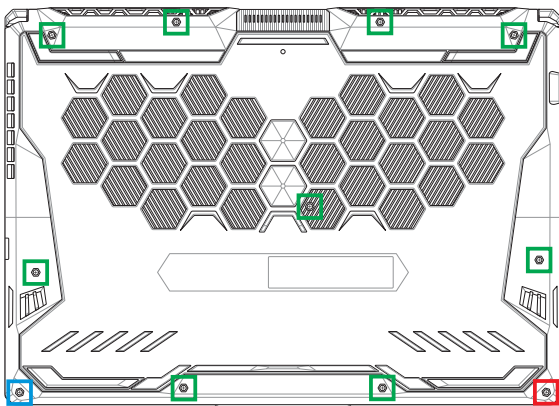

- M2.5 X 12 (9PCS)
- M2.5 X 5.5 (1PC)
- M2.5 X 6 (1PC Pop-open Screw)

Installing a RAM module

Upgrade the memory capacity of your Notebook PC by installing a RAM (Random Access Memory) module in the memory module compartment. The following steps show you how to install a RAM module into your Notebook PC:

WARNING! Disconnect all the connected peripherals, any telephone or telecommunication lines and power connector (such as external power supply, battery pack, etc.) before removing the compartment cover.

IMPORTANT! Visit an authorized service center or retailer for information on RAM module upgrades for your Notebook PC. Purchase RAM modules from authorized retailers of this Notebook PC to ensure maximum compatibility and reliability.

NOTE:

- The appearance of your Notebook PC's bottom view and RAM module may vary per model but the RAM module installation remains the same.
 - It is recommended that you install the RAM module under professional supervision. You may also visit an authorized service center for further assistance.
-

- A. Remove the compartment cover.

NOTE: For more details, refer to the *Removing the compartment cover* section in this manual.

- B. Align and insert the RAM module into the RAM module slot.
C. Push down the RAM module until it clicks in place.

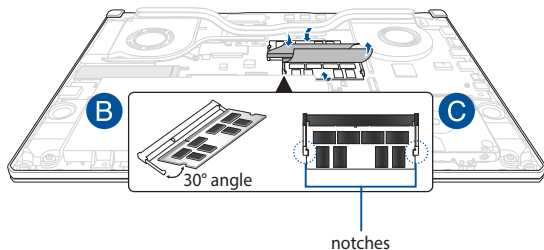

Installing the Hard Disk Drive

Refer to the following steps if you need to install a new HDD (Hard Disk Drive) to your Notebook PC:

IMPORTANT! Purchase an HDD from authorized retailers of this Notebook PC to ensure maximum compatibility and reliability.

WARNING! Disconnect all the connected peripherals, any telephone or telecommunication lines and power connector (such as external power supply, battery pack, etc.) before removing the compartment cover.

NOTE:

- The appearance of your Notebook PC's bottom view and HDD may vary per model but the HDD installation remains the same.
 - It is recommended that you replace the HDD under professional supervision. You may also visit an authorized service center for further assistance.
-

- A. Remove the compartment cover.

NOTE: For more details, refer to the *Removing the compartment cover* section in this manual.

- B. Slightly lift the flap on the connector, then disconnect the cable from the motherboard.
- C. Remove the screw(s) securing the HDD bay to the compartment.
- D. (Optional) If an HDD is currently installed in your Notebook PC, slightly lift the HDD bay out of the compartment.
- E. Disconnect the HDD bay from the HDD cable as shown in the illustration below.

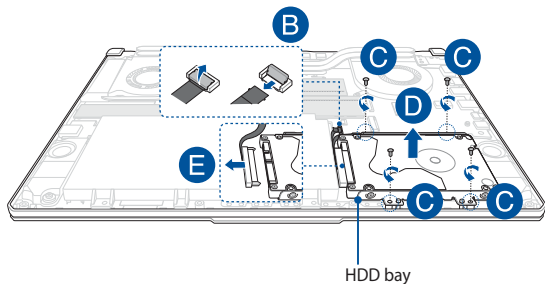

- F. (Optional) If an HDD is currently attached to the HDD bay, refer to the following steps on how to remove the old HDD:
1. Remove all the screw(s) on the sides of the HDD bay.
 2. Remove the old HDD from the HDD bay then place it on a flat dry surface with its PCB (Printed Circuit Board) facing up, as shown in the illustration below.

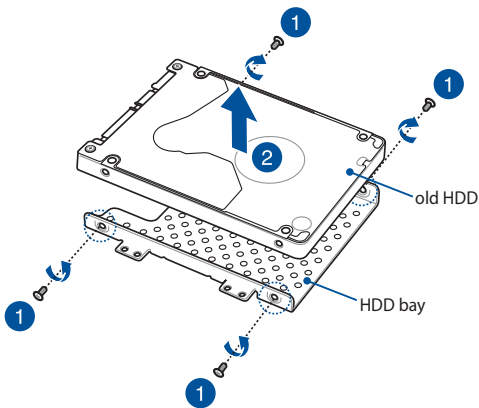

- G. Place the new HDD with its PCB (Printed Circuit Board) facing the HDD bay. Ensure that the port connectors of your HDD are not obstructed by any part of the HDD bay.
- H. Reattach and secure the HDD with the screw(s) you removed earlier.

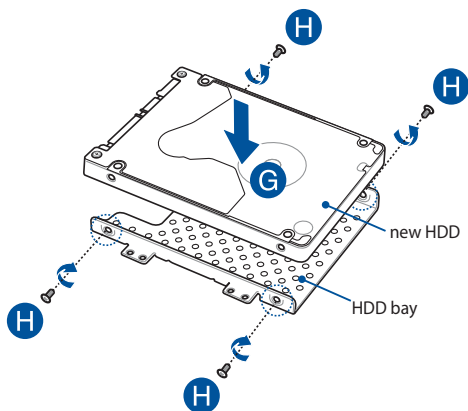

- I. Connect the HDD connector to the HDD.
- J. Replace the HDD bay back in the compartment, and push the HDD bay until seated.
- K. Secure the HDD bay with the screw(s) you removed earlier.
- L. Connect the cable to the motherboard, then push down the flap on the connector to secure the cable.

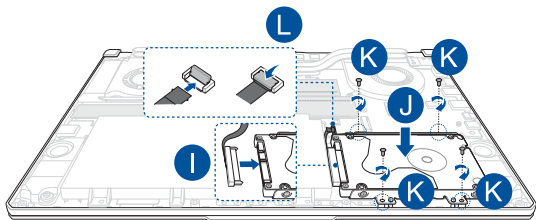

Installing an M.2 card

Refer to the following steps when installing a compatible M.2 card in your Notebook PC:

IMPORTANT! Purchase your M.2 card from authorized retailers of this Notebook PC to ensure maximum compatibility and reliability.

WARNING! Disconnect all the connected peripherals, any telephone or telecommunication lines and power connector (such as external power supply, battery pack, etc.) before removing the compartment cover.

NOTE:

- The appearance of your Notebook PC's bottom view and M.2 card may vary per model but the module installation remains the same.
 - It is recommended that you install the M.2 card under professional supervision. You may also visit an authorized service center for further assistance.
 - The M.2 2280 slot does not support M.2 SATA SSD.
-

- A. Remove the compartment cover.

NOTE: For more details, refer to the *Removing the compartment cover* section in this manual.

- B. Align and insert the M.2 card into the module slot.
- C. Secure the M.2 card in place using the bundled screw(s).

